

User Manual



WFM 601A, WFM 601E & WFM 601M Serial Digital Component Waveform Monitors

071-0103-01

This document supports firmware version 1.00
and above.



Copyright © Tektronix, Inc. All rights reserved.

Tektronix products are covered by U.S. and foreign patents, issued and pending. Information in this publication supercedes that in all previously published material. Specifications and price change privileges reserved.

Printed in the U.S.A.

Tektronix, Inc., P.O. Box 1000, Wilsonville, OR 97070-1000

TEKTRONIX and TEK are registered trademarks of Tektronix, Inc.

WARRANTY

Tektronix warrants that the products that it manufactures and sells will be free from defects in materials and workmanship for a period of three (3) years from the date of shipment. If a product proves defective during this warranty period, Tektronix, at its option, either will repair the defective product without charge for parts and labor, or will provide a replacement in exchange for the defective product.

In order to obtain service under this warranty, Customer must notify Tektronix of the defect before the expiration of the warranty period and make suitable arrangements for the performance of service. Customer shall be responsible for packaging and shipping the defective product to the service center designated by Tektronix, with shipping charges prepaid. Tektronix shall pay for the return of the product to Customer if the shipment is to a location within the country in which the Tektronix service center is located. Customer shall be responsible for paying all shipping charges, duties, taxes, and any other charges for products returned to any other locations.

This warranty shall not apply to any defect, failure or damage caused by improper use or improper or inadequate maintenance and care. Tektronix shall not be obligated to furnish service under this warranty a) to repair damage resulting from attempts by personnel other than Tektronix representatives to install, repair or service the product; b) to repair damage resulting from improper use or connection to incompatible equipment; c) to repair any damage or malfunction caused by the use of non-Tektronix supplies; or d) to service a product that has been modified or integrated with other products when the effect of such modification or integration increases the time or difficulty of servicing the product.

THIS WARRANTY IS GIVEN BY TEKTRONIX IN LIEU OF ANY OTHER WARRANTIES, EXPRESS OR IMPLIED. TEKTRONIX AND ITS VENDORS DISCLAIM ANY IMPLIED WARRANTIES OF MERCHANTABILITY OR FITNESS FOR A PARTICULAR PURPOSE. TEKTRONIX' RESPONSIBILITY TO REPAIR OR REPLACE DEFECTIVE PRODUCTS IS THE SOLE AND EXCLUSIVE REMEDY PROVIDED TO THE CUSTOMER FOR BREACH OF THIS WARRANTY. TEKTRONIX AND ITS VENDORS WILL NOT BE LIABLE FOR ANY INDIRECT, SPECIAL, INCIDENTAL, OR CONSEQUENTIAL DAMAGES IRRESPECTIVE OF WHETHER TEKTRONIX OR THE VENDOR HAS ADVANCE NOTICE OF THE POSSIBILITY OF SUCH DAMAGES.

Service Assurance

If you have not already purchased Service Assurance for this product, you may do so at any time during the product's warranty period. Service Assurance provides Repair Protection and Calibration Services to meet your needs.

Repair Protection extends priority repair services beyond the product's warranty period; you may purchase up to three years of Repair Protection.

Calibration Services provide annual calibration of your product, standards compliance and required audit documentation, recall assurance, and reminder notification of scheduled calibration. Coverage begins upon registration; you may purchase up to five years of Calibration Services.

Service Assurance Advantages

- Priced well below the cost of a single repair or calibration
- Avoid delays for service by eliminating the need for separate purchase authorizations from your company
- Eliminates unexpected service expenses

For Information and Ordering

For more information or to order Service Assurance, contact your Tektronix representative and provide the information below. Service Assurance may not be available in locations outside the United States of America.

Name	VISA or Master Card number and expiration
Company	date or purchase order number
Address	Repair Protection (1,2, or 3 years)
City, State, Postal code	Calibration Services (1,2,3,4, or 5 years)
Country	Instrument model and serial number
Phone	Instrument purchase date

Table of Contents

General Safety Summary	ix
Preface	xi
Getting Started	
Getting Started	1-1
Product Description	1-1
Accessories	1-2
Installation	1-5
Included Accessories	1-5
Hardware Installation	1-5
Connecting Power	1-11
Installing the Waveform Monitor in a Serial Video System	1-12
Functional Check	1-15
Required Equipment	1-15
Initial Equipment Connections	1-16
Functional Check Procedure	1-17
Operating Basics	
Functional Overview	2-1
Front Panel Overview	2-1
Using the Menus	2-5
Rear Panel Connectors	2-6
Reference	
Reference	3-1
Audio Display (WFM 601A Only)	3-1
Bowtie Display	3-5
Calibration	3-7
Configure Menus	3-8
CRT Settings	3-12
Cursors	3-13
Digital List (WFM 601M Only)	3-14
Digital Waveform (WFM 601M Only)	3-16
Eye Display (WFM 601E and WFM 601M Only)	3-19
Filter Menu	3-27
Gain Menu	3-28
Gamut Displays	3-29
Graticule Measurements	3-34
Jitter Measurement Display (WFM 601M Only)	3-37
Line Select	3-39
Multiple Display	3-41
Parade Display	3-41
Picture Display	3-42
Presets	3-43
Ref Mode	3-44

Serial Status	3-44
Sweep	3-52
Vector Display Modes	3-53
Video In	3-58
Waveform Display	3-58

Appendices

Appendix A: Specifications	A-1
Appendix B: Remote Operation	B-1
RS-232 Connector	B-1
Remote Connector	B-1
Appendix C: Remote Command Set	C-1
Cable Measurement Commands	C-3
SLM:CABLe <B8281 B1694 B1505> (WFM 601E and WFM 601M Only) .	C-3
SLM:SOURCE? (WFM 601E and WFM 601M Only)	C-4
SLM:RCVR? (WFM 601E and WFM 601M Only)	C-4
SLM:LEVEL? (WFM 601E and WFM 601M Only)	C-5
SLM:LENGTH? (WFM 601E and WFM 601M Only)	C-5
Configuration Commands	C-6
REFerence: MODE <INT EXT>	C-6
ARROWhead:LIMIT:PAL <MV_700 MV_950>	C-7
ARROWhead:LIMIT:NTSC <IRE_100 IRE_110 IRE_120 IRE_131>	C-7
ARROWhead:FORMat <NTSC PAL AUTO>	C-8
GAMut:GRATicule <ARROWhead DIAMond>	C-8
GAMut:ALarm:TRIGger <NONE CMPST RGB BOTH>	C-9
GAMut:ALarm:DISPlay <SCRN PICT BOTH>	C-9
STANDard <LINES_525 LINES_625 AUTO>	C-10
VECTor:BARs <B100 B75>	C-10
VECTor:GRATicule <LTNG VECTor>	C-11
SERial:MENU <STATUS FORM CABLE>	C-11
SERial:DISPlay <RGB YPbPr>	C-12
SERial:MONitor <GBR YPbPr>	C-12
SERial:EAVSAV <PASS STRIP>	C-13
SERial:ALarm:<error type> <alarm setting>	C-13
UIMENU:<command> <options>	C-14
Cursor Commands	C-16
CURsor:SElect <VOLT TIME VOLT_TIME MARK NONE>	C-16
CURsor:CONTROL <VOLT TIME>	C-17
MC:<ONE TWO THREE> <marker position>	C-17
<VC TC>:<ONE TWO> <voltage level timing range>	C-18
<TC VC>:TRACK <ON OFF>	C-19
Digital Waveform and Digital List Commands	C-20
DGTL? (WFM 601M Only)	C-20
DGTL:REGion? (WFM 601M Only)	C-21
DGTL:DATA? (WFM 601M Only)	
DGTL:DATA:V#?	C-21
DGTL:VDATA? (WFM 601M Only)	C-22
DGTL:VIDmode <VIDEO DATA> (WFM 601M Only)	C-23
DGTL:FReeze <ON OFF> (WFM 601M Only)	C-23
DGTL:BASE <HEX DECIMAL BINARY> (WFM 601M Only)	C-24

Display Commands	C-25
DISPlay:SINGLE <display mode>	C-25
DISPlay:INTENSITY:<display mode>:<line select mode> <intensity>	C-26
DISPlay:INTENSITY:READ <intensity>	C-27
DISPlay:INTENSITY:AUDIO <intensity> (WFM 601A Only)	C-28
DISPlay:PIXC <contrast range>	C-28
DISPlay:PIXB <blackness range>	C-28
DISPlay:TRACEROT <tracerotate>	C-29
DISPlay:SCALEillum <scale>	C-29
DISPlay:FOCUS:<line select mode> <range>	C-30
Error Commands	C-31
ESR?	C-31
ALLEV?	C-31
Eye Pattern Commands	C-33
EYe:DISPlay < FLAT EQEYE> (WFM 601M Only)	C-33
EYe:MODE <OVERLAY EYE10> (WFM 601E and WFM 601M Only)	C-33
EYe:CLOckhpf <E10HZ E100HZ E1000HZ> (WFM 601E and WFM 601M Only)	C-34
Gain Commands	C-35
GAIN:AUDIO <DBU0 DBU4 DBU8 DBU12> (WFM 601A Only)	C-35
GAIN:W_V_STATE <x1 x5 x10>	C-35
GAIN:<WFM VEC>:VAR:STATE <ON OFF>	C-36
GAIN:<WFM VEC>:VAR:VALUE <gain>	C-36
GAIN:LTNG:VAR:<VERT HORZ>:STATE <ON OFF>	C-37
GAIN:LTNG:VAR:<VERT HORZ>:VALUE <gain>	C-37
Input Commands	C-38
INput:SOUrce <SERIALA SERIALB>	C-38
INput:CHANnel <CH1 CH2 CH3>	C-39
INput:PBPROFFSet <MV_0 MV_350>	C-39
Jitter Measurement Commands	C-40
JITter:HPFILter <J10HZ J1000HZ J10KHZ J100KHZ> (WFM 601M Only)	C-40
JITter:UNITS <SEC UI OFF> (WFM 601M Only)	C-40
JITter:<ALIGNMENT TIMING >? (WFM 601M Only)	C-41
Line Select Commands	C-42
LINESelect:<command> <options>	C-42
Position Commands	C-44
POSition:VERTical:<display mode> <range> POSition:HORZ:<display mode> <range>	C-44
Preset Commands	C-46
PREset:REcall <PRESETn FACTORY >	C-46
PREset:STORE <PRESETn>	C-46
PREset:NAMES:<PRESETn> “any string”	C-47
Sweep Commands	C-48
SWEEP:TIMING <ONEL TWOL ONEF TWOF>	C-48
SWEEP:TIMING <ONEL ONEF>	C-49
SWEEP:MAG <OFF ON>	C-49
System Commands	C-50
MENU <FILTer CURsor LINESelect CONFIG GAIN CRT CLear SERial>	C-50

FILTer <FLAT DIFF LP>	C-51
AFC <ON OFF>	C-51
PORT:ECHO <ON OFF>	C-52
ROTEST <ON OFF>	C-52
SNID?	C-53
CALSignal:ENable <OFF ON>	C-53
Remote Command Processing Code	C-55
Appendix D: User Service	D-1
Cleaning or Replacing the Fan Filter	D-1
Fuse Replacement	D-1
Graticule Light Replacement	D-2
Cleaning	D-3
Replacing the CRT Filter	D-3

Glossary

Index

List of Figures

Figure 1–1: Dimensions of the 1700F00 plain cabinet	1–6
Figure 1–2: 1700F02 portable cabinet	1–7
Figure 1–3: Rear view of the waveform monitor in a 1700F02 cabinet	1–8
Figure 1–4: The 1700F05 rack cabinet holds two instruments	1–9
Figure 1–5: 1700F05 cabinet showing utility drawer and blank panel	1–10
Figure 1–6: Monitoring the video bit stream of a serial receiver	1–12
Figure 1–7: Monitoring serial digital signals around a routing switcher	1–13
Figure 1–8: Eye Pattern display of a termination with good return loss	1–14
Figure 1–9: Eye Pattern display of a termination with poor return loss	1–14
Figure 1–10: Initial equipment connections	1–16
Figure 1–11: Initial display in the Waveform display mode	1–18
Figure 1–12: Channel 1 of Color bar with CRT adjustments visible .	1–19
Figure 1–13: Eye Pattern display mode	1–20
Figure 1–14: Jitter display mode	1–21
Figure 1–15: Vector display for 100% Color bar signal	1–22
Figure 1–16: Lightning display for 100% Color bar signal	1–22
Figure 1–17: Arrowhead gamut display	1–23
Figure 1–18: Diamond gamut display	1–24
Figure 1–19: Video digital waveform	1–25
Figure 1–20: Data digital waveform	1–26
Figure 1–21: Typical Audio display with small phase error	1–26
Figure 2–1: WFM 601M front panel	2–1
Figure 2–2: WFM 601A and WFM 601E front panels	2–2
Figure 2–3: Elements of the waveform monitor menu controls	2–5
Figure 2–4: Rear panel of the waveform monitor	2–6
Figure 3–1: A signal from one channel only	3–1
Figure 3–2: X and Y signal in phase with equal amplitudes	3–2
Figure 3–3: Signals out of phase with equal amplitudes	3–2
Figure 3–4: Signals out of phase with unequal amplitudes	3–3
Figure 3–5: Signals with reverse polarity and equal amplitudes	3–3
Figure 3–6: Signals with a phase error of 90 degrees and equal amplitudes	3–3
Figure 3–7: Typical Audio display pattern with small phase error ..	3–4

Figure 3–8: Typical Bowtie display on the waveform monitor	3–5
Figure 3–9: Bowtie waveform showing a timing error in CH 3	3–6
Figure 3–10: Bowtie waveform showing gain error in CH 3	3–6
Figure 3–11: Configure menu for WFM/VEC showing the selection knob	3–8
Figure 3–12: Map of functions available in the Configure menu	3–9
Figure 3–13: Example of the Digital List display	3–14
Figure 3–14: Data List display mode in the Video mode	3–15
Figure 3–15: Digital Waveform display in the VIDEO mode	3–16
Figure 3–16: Digital Waveform display in DATA mode	3–17
Figure 3–17: Digital Waveform display showing X5 gain on CH 1 (Y) waveform	3–18
Figure 3–18: Overlay Eye display	3–20
Figure 3–19: 10-EYE triggered display	3–21
Figure 3–20: Connections for measuring a serial source	3–22
Figure 3–21: Timing Cursors alignment for measuring 20–80% rise time	3–24
Figure 3–22: Construction of the Diamond display	3–29
Figure 3–23: Out-of-gamut signals on a Diamond display	3–30
Figure 3–24: NTSC and PAL Arrowhead gamut displays	3–31
Figure 3–25: Waveform measurement graticule	3–34
Figure 3–26: Graticule for K-factor measurements	3–35
Figure 3–27: Example of the Jitter display	3–37
Figure 3–28: Parade display of YPbPr shown in Line Select mode (15H only)	3–40
Figure 3–29: Parade display of Y and Pb signals	3–41
Figure 3–30: Example of the Picture display	3–42
Figure 3–31: Serial STATUS display for firmware V2.X	3–45
Figure 3–32: Serial STATUS display for firmware V1.X	3–47
Figure 3–33: Serial format display showing the FORMAT screen ...	3–48
Figure 3–34: Serial format display showing the Cable screen	3–49
Figure 3–35: Connection for point-to-point error measurements ...	3–50
Figure 3–36: Vector display relationship of the Pr and Pb signals ...	3–53
Figure 3–37: Vector display graticule	3–54
Figure 3–38: Construction of the Lightning display	3–55
Figure 3–39: Lightning graticule showing interchannel timing errors	3–56
Figure B–1: Pin assignments for the RS-232 connector	B–1
Figure B–2: Pin assignments for the REMOTE connector	B–2
Figure D–1: Graticule light bulb replacement	D–2

List of Tables

Table 3–1: List of measured and actual rise times for the waveform monitor	3–25
Table A–1: Electrical specifications	A–1
Table A–2: CRT display	A–8
Table A–3: AC power source	A–9
Table A–4: Environmental characteristics	A–9
Table A–5: Physical characteristics	A–9
Table A–6: Safety standards	A–10
Table A–7: Safety certification compliance	A–10
Table A–8: Certifications and compliances	A–11
Table B–1: Remote connector pin assignments and functions	B–2
Table C–1: Symbols used in this section	C–1
Table C–2: SERIAL:ALarm: commands and options	C–14
Table C–3: UIMENU: commands and options	C–15
Table C–4: Voltage and Timing Cursor positioning commands and options	C–18
Table C–5: Voltage and Timing Cursor tracking commands and options	C–19
Table C–6: DISPLAY:SINGLE commands	C–25
Table C–7: DISPLAY:INTENSITY command options	C–27
Table C–8: DISPLAY:FOCUS command options	C–30
Table C–9: Typical ALLEV? responses to detected system errors. ..	C–32
Table C–10: LINESelect: commands and options	C–42
Table C–11: POSition:VERTical commands and options	C–45
Table C–12: POSition:HORZ commands and options	C–45
Table C–13: FILTER command options	C–51

General Safety Summary

Review the following safety precautions to avoid injury and prevent damage to this product or any products connected to it.

Only qualified personnel should perform service procedures.

To avoid potential hazards, use this product only as specified.

Injury Precautions

Use Proper Power Cord. To avoid fire hazard, use only the power cord specified for this product.

Avoid Electric Overload. To avoid electric shock or fire hazard, do not apply a voltage to a terminal that is outside the range specified for that terminal.

Ground the Product. This product is grounded through the grounding conductor of the power cord. To avoid electric shock, the grounding conductor must be connected to earth ground. Before making connections to the input or output terminals of the product, ensure that the product is properly grounded.

Do Not Operate Without Covers. To avoid electric shock or fire hazard, do not operate this product with covers or panels removed.

Use Proper Fuse. To avoid fire hazard, use only the fuse type and rating specified for this product.

Do Not Operate in Wet/Damp Conditions. To avoid electric shock, do not operate this product in wet or damp conditions.

Do Not Operate in an Explosive Atmosphere. To avoid injury or fire hazard, do not operate this product in an explosive atmosphere.

Product Damage Precautions

Use Proper Power Source. Do not operate this product from a power source that applies more than the voltage specified.

Provide Proper Ventilation. To prevent product overheating, provide proper ventilation.

Do Not Operate With Suspected Failures. If you suspect there is damage to this product, have it inspected by qualified service personnel.

Symbols and Terms

Terms in this Manual. These terms may appear in this manual:



WARNING. *Warning statements identify conditions or practices that could result in injury or loss of life.*



CAUTION. *Caution statements identify conditions or practices that could result in damage to this product or other property.*

Terms on the Product. These terms may appear on the product:

DANGER indicates an injury hazard immediately accessible as you read the marking.

WARNING indicates an injury hazard not immediately accessible as you read the marking.

CAUTION indicates a hazard to property including the product.

Symbols on the Product. The following symbols may appear on the product:



DANGER
High Voltage



Protective Ground
(Earth) Terminal



ATTENTION
Refer to Manual



Double
Insulated

Certifications and Compliances

Refer to the specifications section for a listing of certifications and compliances that apply to this product.

Preface

This manual describes the capabilities of the WFM 601A, WFM 601E, and WFM 601M Serial Digital Component Waveform Monitors and their features and specifications.

To get started, refer to the first section, *Getting Started*. This section shows you how to install and configure the waveform monitor for use in your operating environment. For detailed information about a feature, refer to the third section, *Reference*.

About This Manual

This manual is composed of the following sections:

- *Getting Started* provides a product description, installation instructions, and a functional check procedure. Standard and optional accessories are also listed.
- *Operating Basics* briefly describes the front panel controls and rear panel connections.
- *Reference* provides an alphabetized reference for all display modes and configurable features of the waveform monitor.
- *Appendices* provides additional information including the specifications, remote control interfaces, and maintenance procedures.

Related Manuals

The following related document is also available.

- The *WFM 601A, WFM 601E, and WFM 601M Service Manual* (070-9836-XX) describes how to service the waveform monitors. This optional manual may be ordered separately.

Complete and mail the Warranty Reply Card packaged with this manual to ensure that you receive notifications of firmware or hardware upgrades.

Contacting Tektronix

Product Support	<p>For application-oriented questions about a Tektronix measurement product, call toll free in North America: 1-800-TEK-WIDE (1-800-835-9433 ext. 2400) 6:00 a.m. – 5:00 p.m. Pacific time</p> <p>Or contact us by e-mail: tm_app_supp@tek.com</p> <p>For product support outside of North America, contact your local Tektronix distributor or sales office.</p>
Service Support	<p>Contact your local Tektronix distributor or sales office. Or visit our web site for a listing of worldwide service locations.</p> <p>http://www.tek.com</p>
For other information	<p>In North America: 1-800-TEK-WIDE (1-800-835-9433) An operator will direct your call.</p>
To write us	<p>Tektronix, Inc. P.O. Box 1000 Wilsonville, OR 97070-1000</p>



Getting Started

Getting Started

This section presents information you need to set up your waveform monitor and to check that it is functional. This section contains the following information:

- *Product Description* gives an overview of the product capabilities.
- *Accessories* lists the standard and optional accessories.
- *Installation* describes how to set up the waveform monitor for use.
- *Functional Check* gives a procedure to verify the primary functions of your waveform monitor.

Product Description

The waveform monitors measure and display 4:2:2 component serial digital signals. A waveform monitor displays serial digital signals as the familiar component signals, as an Eye pattern, as digital data or in a variety of standard measurement modes. Use the EDH (Error Detection and Handling) system and the suite of automated checks of the serial digital format to verify data integrity. Refer to *Appendix A: Specifications* for details of the waveform monitor performance.

Features

The waveform monitors offers the following features:

- Two 270 Mbit serial component loop-through inputs
- Digital video standards SMPTE 259M, ITU-R BT.656, and ITU-R BT.601
- RGB and Y-P_B-P_R display format for 525 and 625 line signals
- Eye Pattern display with Timing and Voltage Cursors on the WFM 601E and the WFM 601M
- Jitter demodulator with numeric jitter readout and video correlated jitter waveform display on the WFM 601M
- Parade or Waveform display of Y, P_B, and P_R component signals
- Digital Waveform and Data displays with Data-cursor correlation between display modes on the WFM 601M
- RGB and composite Gamut checks with Diamond and Arrowhead displays
- Field, line, and word (WFM 601M only) select with readout and bright up of selected lines on Picture Monitor Out (Y or G Channel)

- SMPTE RP-165 standard EDH indicator for presence
- Embedded Audio identification
- Analog audio Lissajous display on the WFM 601A
- Source signal level meter and cable-length readout on the WFM 601E and the WFM 601M
- Lightning and Vector displays
- Reclocked Serial Component Digital output following A/B switching
- Video Reference: Internal Serial Component signal (follows A/B switching) or external composite

Menus An expanded feature set is available through the menus. You select menu items with multi-use bezel buttons and knobs. When you select a menu item, such as Voltage Cursors, on-screen labels show the current function of the bezel buttons and knobs.

Calibrator The waveform monitors provide an internal calibrator signal to set both vertical and horizontal gain. The calibrator signal is a 700 mV, 100 kHz signal. Press the CONFIG button and use the bezel knob to select the Calibrate menu. Press the CAL SIG button to turn on the calibrator signal.

Accessories

The waveform monitor is shipped with several standard accessories. These standard accessories and any optional accessories are listed here.

Standard Accessories The following accessory items are included with this product:

- 1 User Manual, this manual (071-0103-XX)
- 1 Power Cord: United States and Japan only (161-0216-XX)
- 1 Replacement Fuse Cartridge: 3AG, 2A, 250 V, fast-blow (159-0021-00)
- 3 Replacement Gaticule Light Bulbs (150-0168-00)
- 3 Replacement Air Filters for Fan (378-0415-00)
- 2 75 Ω High-frequency, End-line Terminations: 26 dB to 300 MHz (011-0163-00)
- 1 Smoke Grey CRT Filter, installed on instrument (378-0258-00)

Options The following options are available when ordering a waveform monitor.

Power Cord Options. If you do not specify a power cord option, the waveform monitor is shipped with a North American 125 V power cord and one replacement fuse. The following power cord options are available when purchasing your waveform monitor.

Power cords for use in North America are UL listed and CSA certified. Cords for use in areas other than North America are approved by at least one test house acceptable in the country to which the product is shipped.

- **Option A1.** Power, Universal Europe, 220 V/16 A (Locking Power Cord)
- **Option A2.** Power, United Kingdom, 240 V/15 A (Power Cord)
- **Option A3.** Power, Australia, 240 V/10 A (Power Cord)
- **Option A4.** Power, North America, 250 V/10 A (Power Cord)
- **Option A5.** Power, Swiss, 240 V/6 A (Power Cord)

Optional Accessories

The following items can be ordered with the monitor or purchased through a Tektronix field office or distributor. When ordering, include both the name and part number (if available) of the option.

WFM 601A, WFM 601E, and WFM 601M Service Manual. (070-9836-XX) Provides module-level troubleshooting information plus information to help identify components, such as schematics, component locaters, and a complete parts list.

Front Panel Cover. The front panel cover protects the display face from damage and dust.

1700F00 Plain Cabinet. This rack mount cabinet is half-rack width, made of durable metal and painted silver-gray. Ventilating holes in the top, bottom, and sides of the cabinet help dissipate heat.

1700F02 Carrying Case. This portable cabinet is similar to the 1700F00, but it has rubber feet, a carrying handle, a flipstand, and a front cover.

1700F05 Side-by-Side Rack Adapter. The 1700F05 allows you to mount two half-rack width instruments in a standard 19-inch rack.

1700F06 Blank Panel. When you use only one side of a 1700F05 enclosure, insert a 1700F06 Blank Panel in the unused side to improve appearance and air flow.

1700F07 Utility Drawer. When you use only one side of a 1700F05, install the 1700F07 utility drawer in the unused side to provide storage and improve appearance and air flow. The drawer opens and closes freely, unless latched for transport.

Installation

This section provides instructions for installing the waveform monitor into a standard rack or one of the optional cases. At installation time, save the shipping carton and packing materials (including the anti-static bag) in case you need to ship the instrument.

Included Accessories

The waveform monitor is shipped with several accessory items which may be required for normal use. For more information on accessories, refer to page 1–2.

Hardware Installation

Because operating environments vary, the waveform monitor is not shipped with a cabinet unless you have ordered one. All qualification testing for the waveform monitor was performed in a 1700F00 cabinet. To guarantee compliance with specifications, you should operate the waveform monitor in one of the cabinets described here.

Cabinets

The cabinets offered for the waveform monitor provide EMI shielding, protect against electrical shock, and protect against the accumulation of dust. Figure 1–1 shows the plain cabinet, option 1700F00. A rear panel fan supplies filtered, cooling air which exits through the cabinet vent holes. Restricting the air flow through the vents or the rear fan can lead to an excessive internal temperature.

NOTE. *To meet EMI emission specifications, the waveform monitor must be installed in a Tektronix 1700F00, 1700F02, or 1700F05 enclosure. The enclosure front edges must securely contact the conductive front bezel on all four sides.*

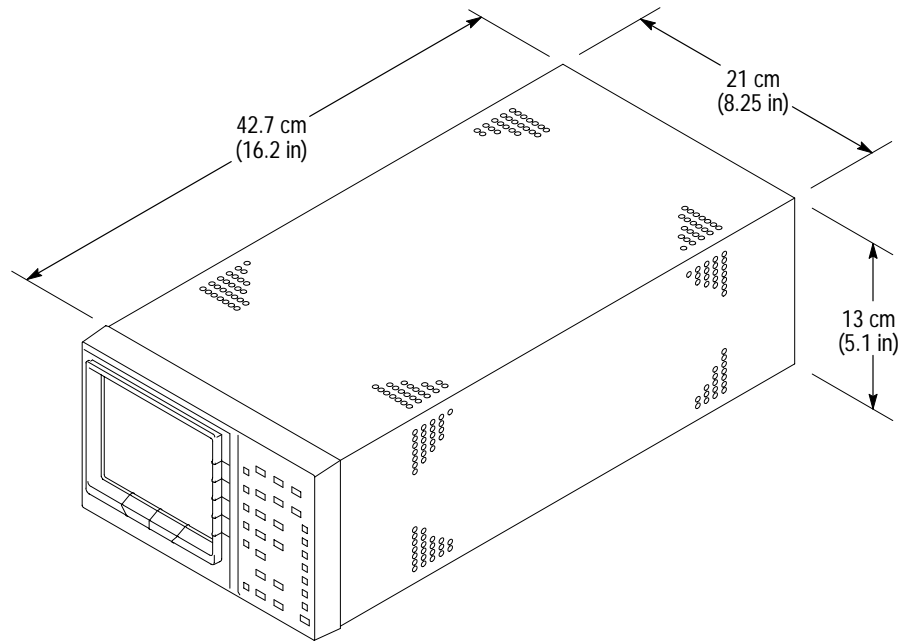

Figure 1-1: Dimensions of the 1700F00 plain cabinet

The optional 1700F00 cabinet is the basic element for all of the cabinets. The 1700F02 Portable carrying case is an enhanced version of the 1700F00 cabinet, as is the 1700F05 side-by-side rack mount assembly. All cabinets are available from your Tektronix representative.

The portable cabinet, 1700F02, is shown in Figure 1–2. The 1700F02 has a handle, four feet, and a flip-up stand. The mounting hole sizes and spacing are different from those of the 1700F00.

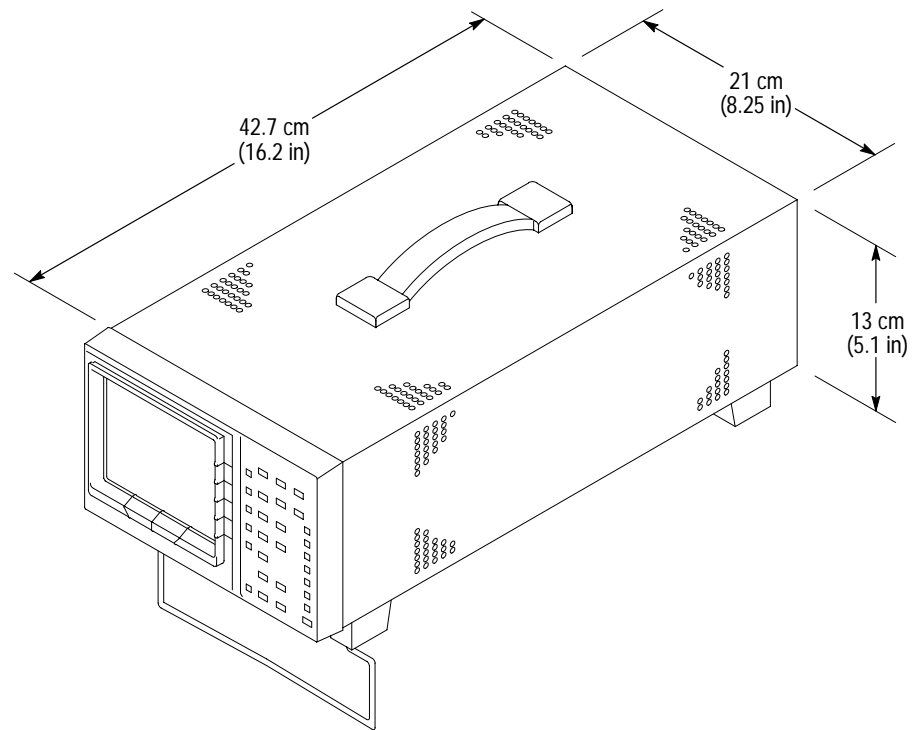

Figure 1–2: 1700F02 portable cabinet

Installing the Waveform Monitor in a Cabinet

Secure the waveform monitor in a cabinet using two 6-32 Pozidrive® screws. Figure 1-3 shows the location of these screws on the rear panel.



CAUTION. Do not carry a waveform monitor in a cabinet without installing the rear panel mounting screws. Without the mounting screws, there is nothing to keep the waveform monitor in its cabinet.

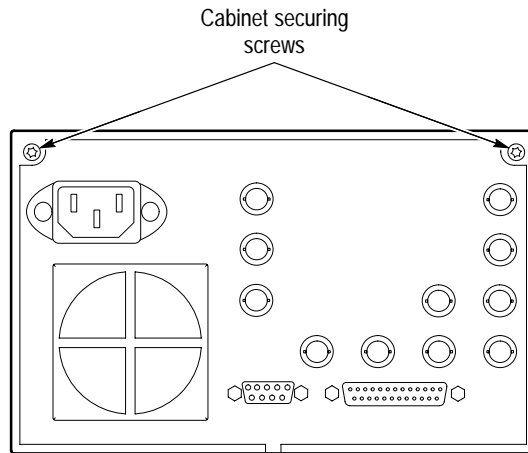

Figure 1-3: Rear view of the waveform monitor in a 1700F02 cabinet

Rack Adapter The optional 1700F05 side-by-side rack adapter, shown in Figure 1–4, consists of two attached cabinets. Use it to mount the waveform monitor and another half-rack width instrument, such as an analog component monitor, in a standard 19-inch rack.

You can adjust the rack adapter so that the waveform monitor is aligned with other equipment in the rack. See Figure 1–4.

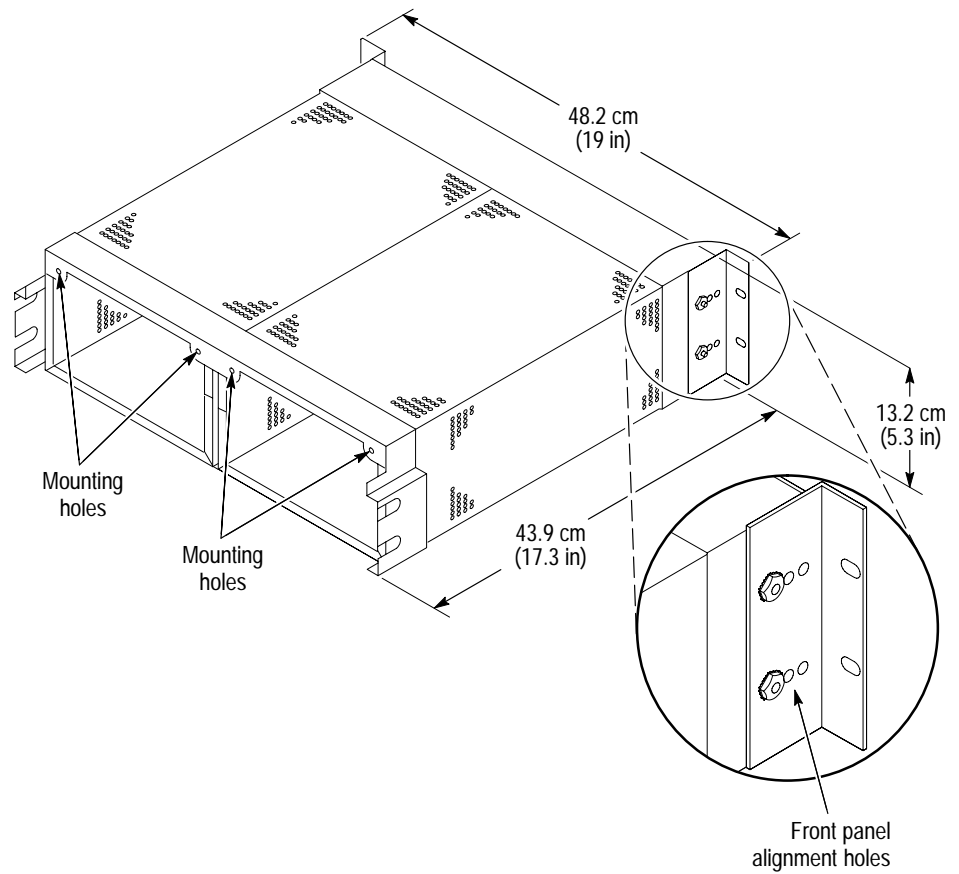

Figure 1–4: The 1700F05 rack cabinet holds two instruments

If you are using only one side of the rack adapter, insert a blank panel (1700F06) or an accessory drawer (1700F07) in the unused section to improve airflow and appearance. Figure 1–5 shows the blank panel and drawer.

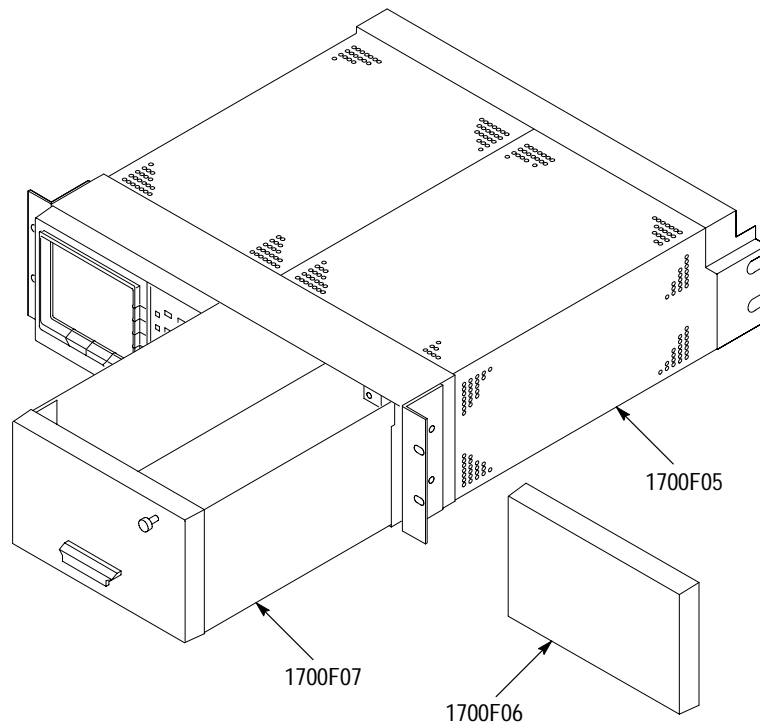

Figure 1-5: 1700F05 cabinet showing utility drawer and blank panel

Repackaging for Shipment

To ship the waveform monitor to a Tektronix Service Center for service, follow these instructions:

1. Attach a tag to the waveform monitor showing the name of the owner, the complete address, the phone number, the instrument serial number and a description of the required service.
2. Repackage the instrument in the original packaging materials. If the original packaging materials are not available, follow these instructions:
 - a. Obtain a carton of corrugated cardboard having inside dimensions at least six inches greater than the dimensions of the instrument. Use a shipping carton that has a test strength of at least 275 pounds.
 - b. Surround the instrument with a protective bag (anti-static preferred). For instruments that are not in a cabinet, wrap a cardboard piece around the bagged instrument to protect internal components.

- c. Pack dunnage or urethane foam between the instrument and the carton. If using Styrofoam kernels, overfill the box and compress when closing the lid. You need three inches of cushioning on all sides of the instrument.
3. Seal the carton with shipping tape or industrial staples.

Connecting Power

The waveform monitor operates from a single-phase power source with the neutral conductor at or near earth ground. The line conductor is fused for over-current protection. A protective ground connection through the grounding conductor in the power cord is essential for safe operation.



WARNING. *When power is supplied, line voltage will be present in the waveform monitor, even if the POWER switch is set to STANDBY.*

AC Power Requirements

The waveform monitor operates from an AC line frequency of 50 or 60 Hz, over the range of 90–250 Volts, without the need for configuration, except the power cord. Refer to page 1–2 for the power cord options. The typical power draw is 75 W. Refer to *Appendix A: Specifications* for additional information on power and environmental requirements.

Installing the Waveform Monitor in a Serial Video System

The serial digital monitor can operate almost anywhere in the distribution system due to its high impedance, bridging, loop-through inputs. This section describes two types of connections and presents useful information on line termination.

Most serial equipment employs a receiver that regenerates an output signal, such as the receiver shown in Figure 1–6. Routing the incoming serial signal through one of the waveform monitor loop-through inputs and connecting the output of the serial receiver to the other loop-through input allows you to compare the incoming signal and the regenerated output signal.

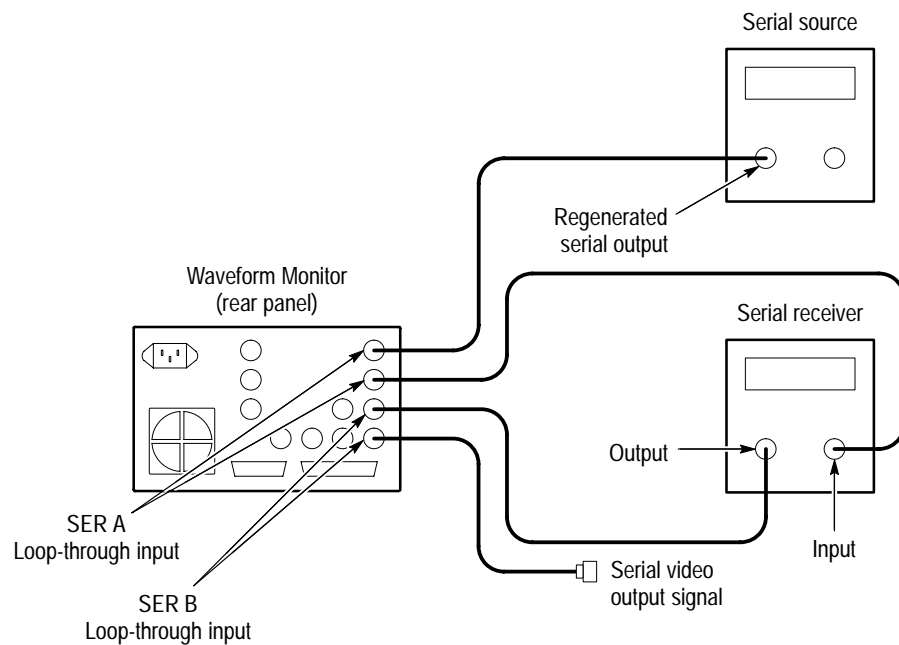

Figure 1–6: Monitoring the video bit stream of a serial receiver

You can use the waveform monitor to check serial digital signals around a routing switcher. It is possible to look at all the inputs to the switcher with the use of a patch panel and the serial monitor as shown in Figure 1–7.

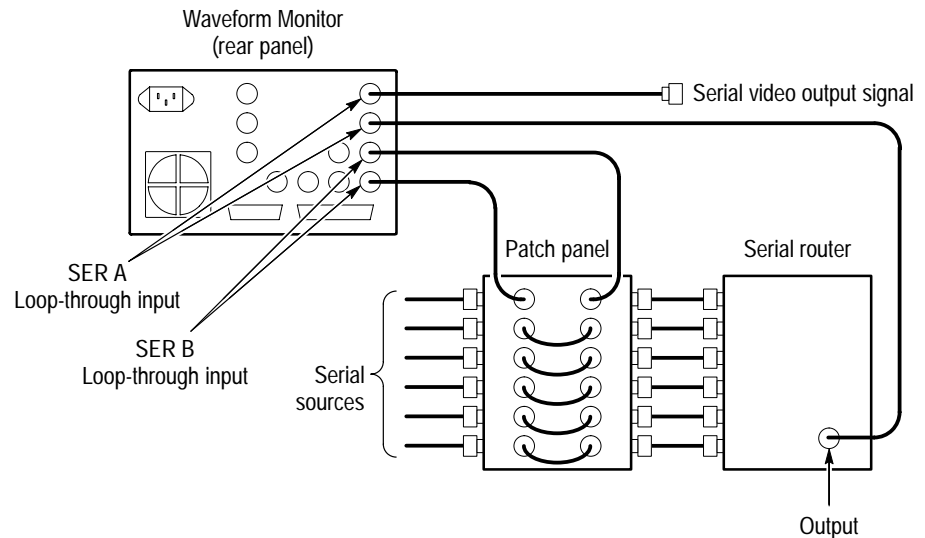

Figure 1–7: Monitoring serial digital signals around a routing switcher

Line Termination

The waveform monitor uses passive loop-through serial inputs, similar in concept to those used in baseband video equipment. Accordingly, the loop-through must be terminated externally. It is important that this external termination meet accuracy and return loss requirements.

If the waveform monitor is installed to monitor an operating link, the destination receiver and the connecting cable serve as the termination. This monitoring connection is best because it checks the performance of the entire serial path. The return loss of the waveform monitor is sufficiently high that, in most cases, the destination receiver sets the system return loss.

In cases where the waveform monitor is placed at the end of a link, a BNC termination must be installed on one side of the loop-through connector. The termination must be $75\ \Omega$ and DC coupled (good return loss extends to DC). Return loss should exceed 25 dB from 10 kHz to 270 MHz. The supplied $75\ \Omega$ terminators meet these requirements.

A terminator can be inspected for return loss problems using the WFM 601M or WFM 601E waveform monitor and a serial source with low aberrations, such as the Tektronix TG 2000 mainframe with a DVG1 Generator module. Connect the generator serial output to one side of the waveform monitor loop-through connector and install the terminator on the other side. Select the EYE mode and observe the Eye Pattern, paying particular attention to leading edge aberrations.

Figure 1–8 shows the Eye Pattern with a good return loss terminator. Figure 1–9 shows the distorted Eye Pattern of a terminator having only 13 dB return loss (capacitive) at 100 MHz. Terminations with aberrations under 10% are acceptable.

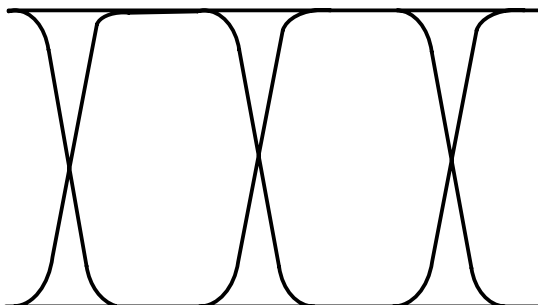

Figure 1–8: Eye Pattern display of a termination with good return loss

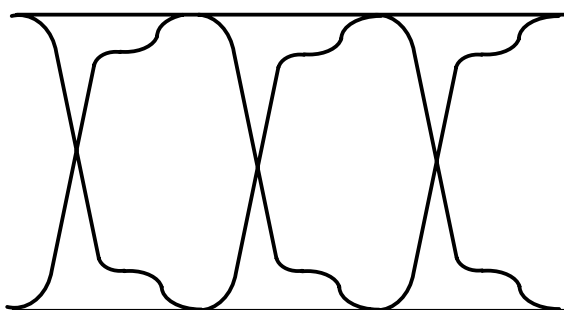

Figure 1–9: Eye Pattern display of a termination with poor return loss

Compatibility of BNC Center Pins. Most video equipment BNC connectors, whether 50 or 75 Ω , use a 50 Ω standard center pin. Some laboratory 75 Ω BNC connectors use a smaller diameter center pin. The BNC connectors on the WFM 601M are designed to work with the 50 Ω standard (large diameter) center pins.

Do not use connectors or terminators with the smaller center pins. They could cause intermittent connections.

Functional Check

The following procedure provides a basic operational check of the waveform monitor. Only instrument functions, not measurement quantities or specifications, are checked in this procedure. Therefore, a minimum amount of test equipment is required.



WARNING. *To avoid personal injury, be sure that a cabinet is installed on the instrument.*

All checks are made with the cabinet installed. The cabinet, an optional accessory, must be installed on the instrument to avoid personal injury, maintain proper environment for the instrument, keep dust out, and provide proper EMI shielding.

If the Functional Check reveals improper operation or an instrument malfunction, check the connections to and the operation of the test equipment. If it is operating normally and the failure is repeatable, send the waveform monitor to qualified service personnel for repair or adjustment.

For a complete check of the instrument performance, refer qualified service personnel to the *Performance Verification Procedure* in the Service manual.

Required Equipment

The following equipment is required to perform this procedure:

- Digital Component Television Signal Generator (1)
Provides 100% Color Bar signal.
For example: The Tektronix TG 2000 Signal Generation Platform with a DVG1 module.
- Function generator (1) (for WFM 601A only)
For example: Tegam FG 503
- Coaxial Cable (1)
42-inch, 75 Ω , RG6 cable (Tektronix Part No. 012-0159-00) or equivalent
- 75 Ω Terminator (1)
End-line (Tektronix Part No. 011-0163-00)

Initial Equipment Connections

Figure 1–10 shows how to configure a signal generator and the waveform monitor to preform the Functional Check procedure.

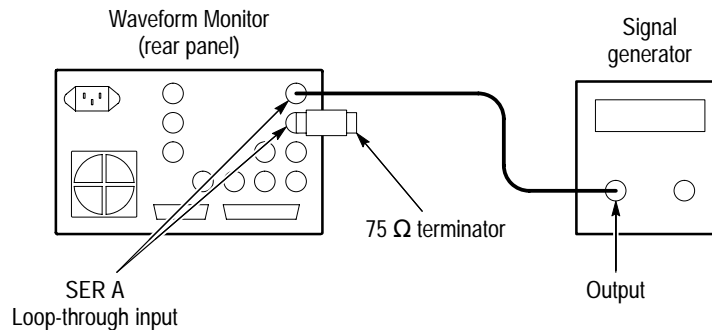

Figure 1–10: Initial equipment connections

Follow these steps to configure the test equipment.

1. Ensure the waveform monitor is enclosed in a cabinet before connecting AC power.
2. Connect the waveform monitor to an appropriate AC power source.
3. Connect the component serial digital output of the signal generator to one side of the SER A input.
4. Terminate the other side of the loop-through the SER A input with the 75 Ω terminator.
5. For the WFM 601A only, connect one of the Function Generator audio outputs to pins 8 and 9 of the REMOTE 25-pin connector; connect the other output to pins 10 and 11. See *Appendix B: Remote Operation* for more information on configuring the waveform monitor's remote connector for audio input. Ensure that the generator amplitude is a nominal 5 V, but not greater than 8 V_{peak}.

This procedure does not check the monitor outputs (MON OUT). To check these outputs, connect a GBR or YP_bP_r analog component monitor and check for the Color bar pattern during the procedure.

Functional Check Procedure

Perform the following steps to check the basic functions.



WARNING. A shock hazard exists in the waveform monitor when it has no cabinet and it is connected to AC power. Always install the waveform monitor in a cabinet before use.

1. Perform steps listed under *Initial Equipment Connections*.
2. Set the video generator to produce a 100% Color Bar signal and to enable its output.
3. Press the front-panel power switch on the waveform monitor. Check that the indicator beside the switch lights up indicating ON.
4. Check that the CRT and graticule light up. When you apply power, the waveform monitor restores its last settings.
5. Initialize the waveform monitor settings. The waveform monitor contains a factory Preset that restores the instrument to factory settings.
 - a. Press the PRESET MENU button.
 - b. Select the FACTORY setting by turning the bezel knob under the list of presets to highlight FACTORY
 - c. Press the bezel button adjacent to RECALL to load the factory preset.
 - d. Check for the Waveform display mode with one channel of the Color Bar signal displayed. Your display should look similar to Figure 1-11.

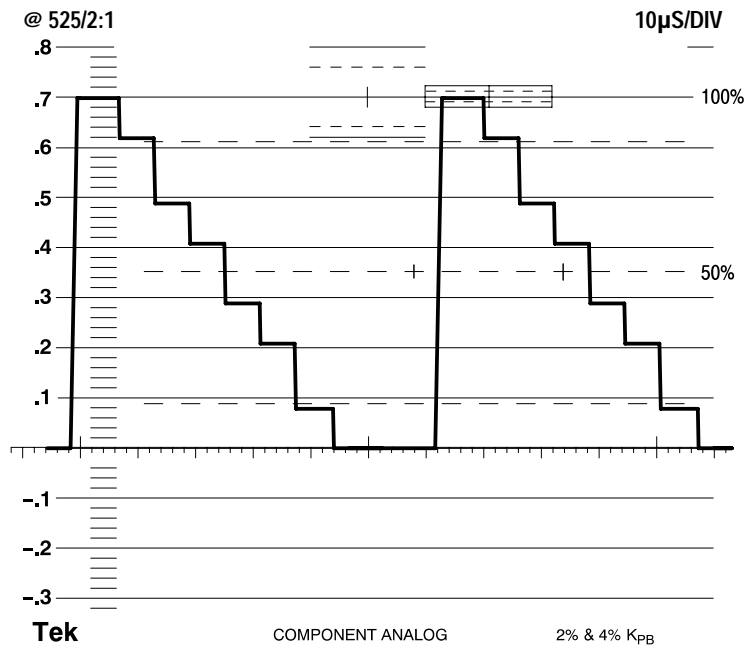

Figure 1-11: Initial display in the Waveform display mode

6. Check the display brightness controls.
 - a. Press the CRT MENU button. The display controls should appear as shown in Figure 1-12.
 - b. Check that you can position the waveform by adjusting the VERT and HORIZ POS bezel knobs. Leave the signal horizontally centered and with the waveform bottom on the 0 V line.

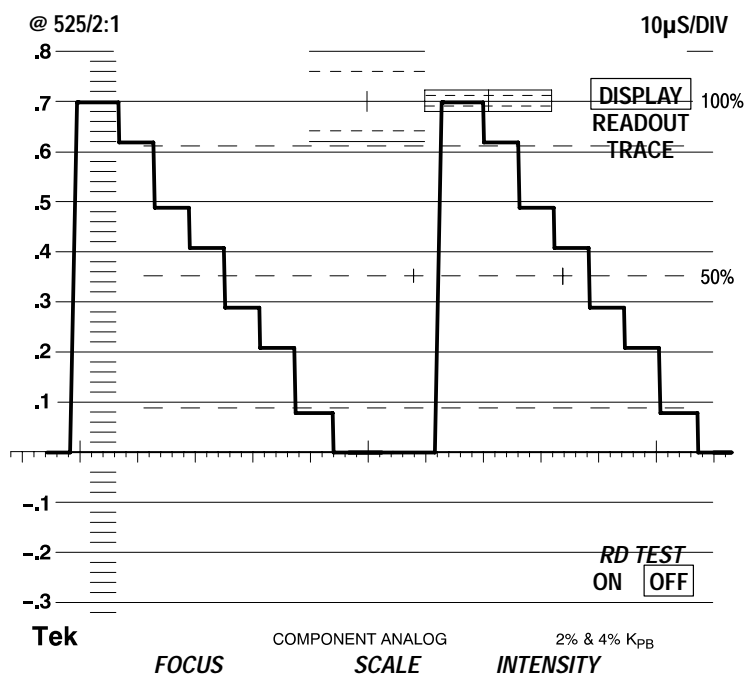

Figure 1-12: Channel 1 of a color bar signal with CRT adjustments visible

- c. Use the bezel knobs under the CRT to adjust the focus, brightness of the graticule scale, and intensity of the trace. Adjust the display controls to the desired viewing levels.
- d. Press the top bezel button to select READOUT. Adjust the readout intensity to the desired level.
- e. Exit the CRT menu by pressing the CRT button. The changes made while the menu was displayed remain in effect.

7. Check the Eye Display mode. (WFM 601E and WFM 601M only)
 - a. Press the EYE/JITTER button to select the Eye display mode. The indicator next to EYE should light.
 - b. Check that the waveform is triggered to produce an Eye display like that in Figure 1–13. The degree of noise on the Eye waveform is determined by the video generator and connecting cables.
 - c. Press the lower bezel button to change from FLAT mode to EYE EQ mode. You should hear the click of a relay and the display will change slightly as the equalization circuit modifies the waveform.
 - d. Press the bezel button again to return to the FLAT mode.

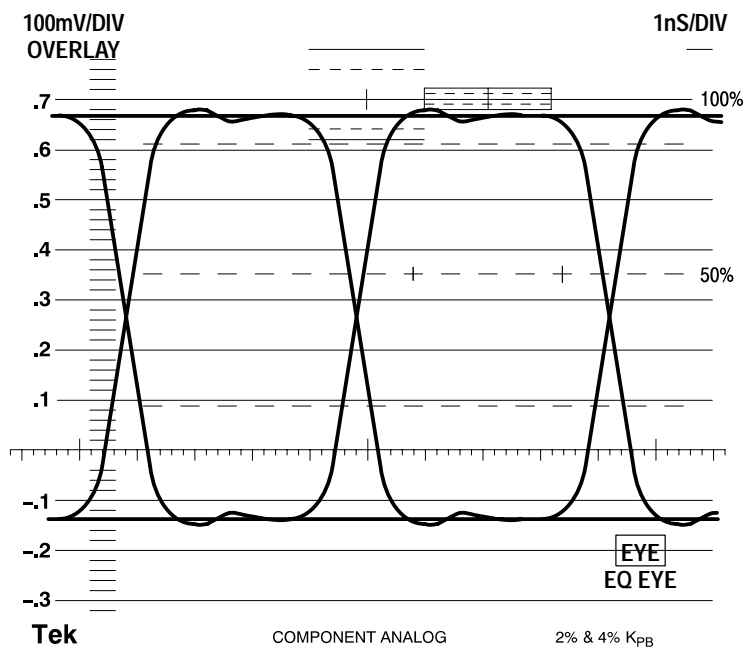

Figure 1–13: Eye Pattern display mode

8. Check the Jitter display mode. (WFM 601M only)
 - a. Press the EYE/JITTER button to select the Jitter display mode. The indicator next to JITTER should light.
 - b. The Jitter display should resemble that shown in Figure 1–14. Your jitter readout values may differ from those in Figure 1–14. Jitter values are affected by the quality of the signal source and connecting cables.

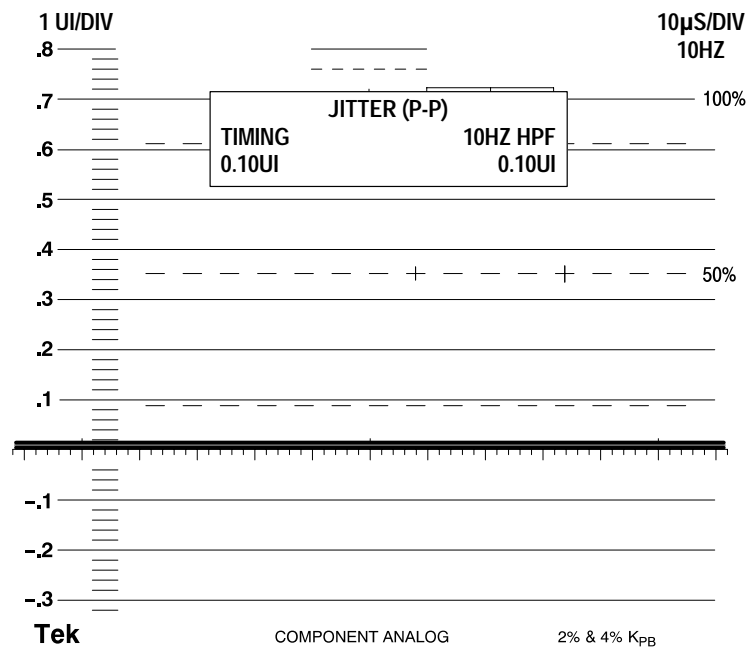

Figure 1-14: Jitter display mode

9. Check the Vector display modes.
 - a. Press the VECTOR/GAMUT button to select the Vector mode. The indicator next to VECTOR should light.
 - b. Check that the display looks like the Vector display pictured in Figure 1-15.
 - c. If the display does not appear as illustrated, ensure that the generator is set to output a 100% Color Bar signal.
 - d. Press the bezel button labeled VECTOR/LIGHTNING to select the Lightning display.
 - e. Check that the display looks like the Lightning display pictured in Figure 1-16.

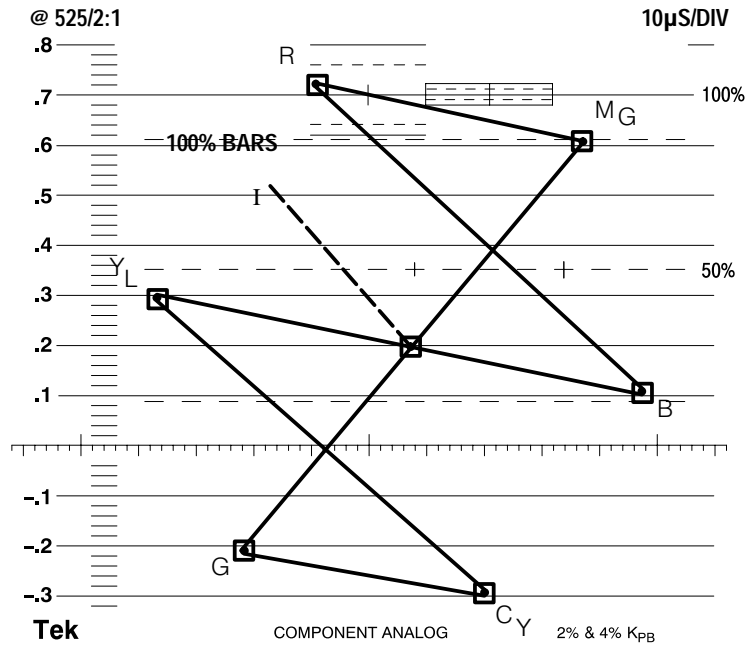

Figure 1-15: Vector display for a 100% Color Bar signal

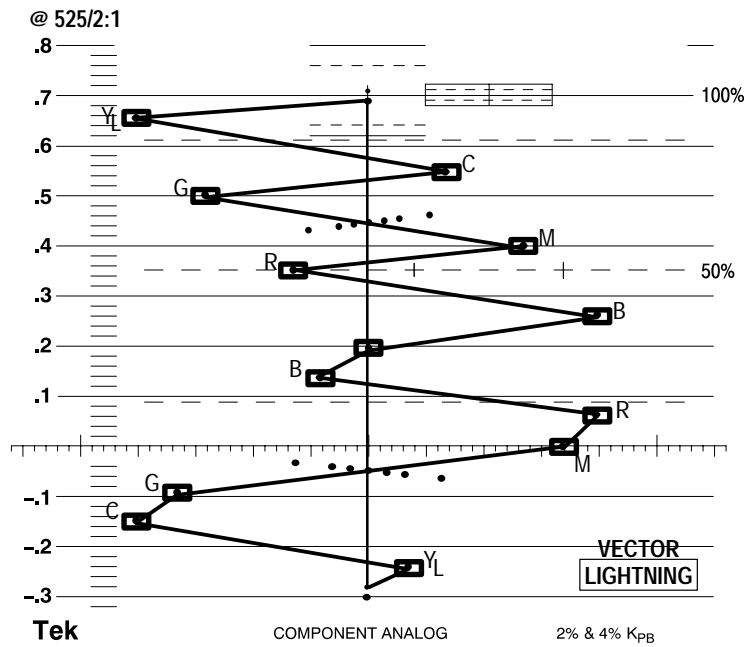

Figure 1-16: Lightning display for a 100% Color Bar signal

10. Check the Gamut display modes.

- a. Press the VECTOR/GAMUT button to select the GAMUT display mode. The indicator next to GAMUT should light up.
- b. If the bezel button labeled DIAMOND/ARROWHEAD does not have Arrowhead selected, press that bezel button to select ARROWHEAD.
- c. Check that the display looks like the Arrowhead gamut display in Figure 1-17.

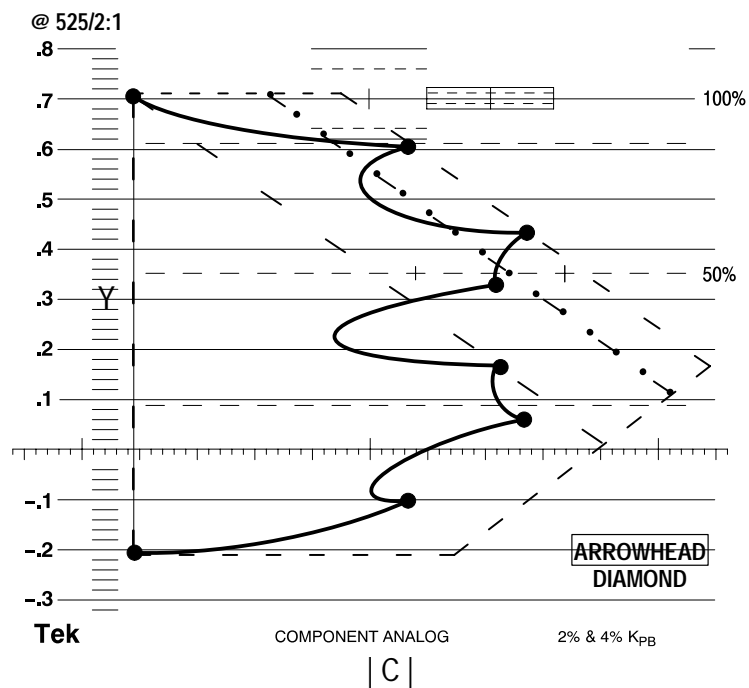

Figure 1-17: Arrowhead gamut display

- d. Press the bezel button again to select the Diamond display mode.
- e. Check that the display looks like the Diamond gamut display in Figure 1-18.

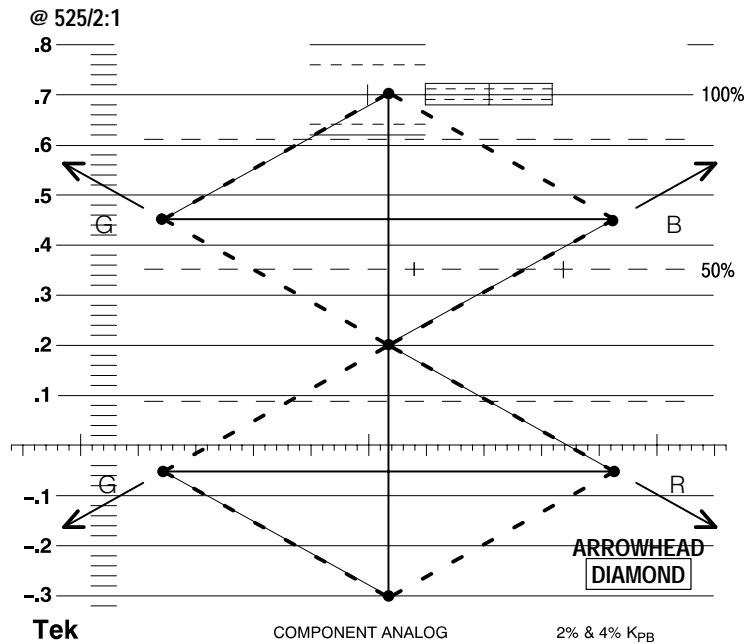

Figure 1-18: Diamond gamut display

- 11. Check the Digital Waveform display modes. (WFM 601M only)
 - a. Press the DGTL WFM/DGTL LIST button to select the Digital Waveform display mode. The indicator next to DGTL WFM should light up.
 - b. If the bezel button labeled VIDEO/DATA does not have VIDEO selected, press that bezel button to select VIDEO.
 - c. Check that the display looks like the Video digital waveform display in Figure 1-19.

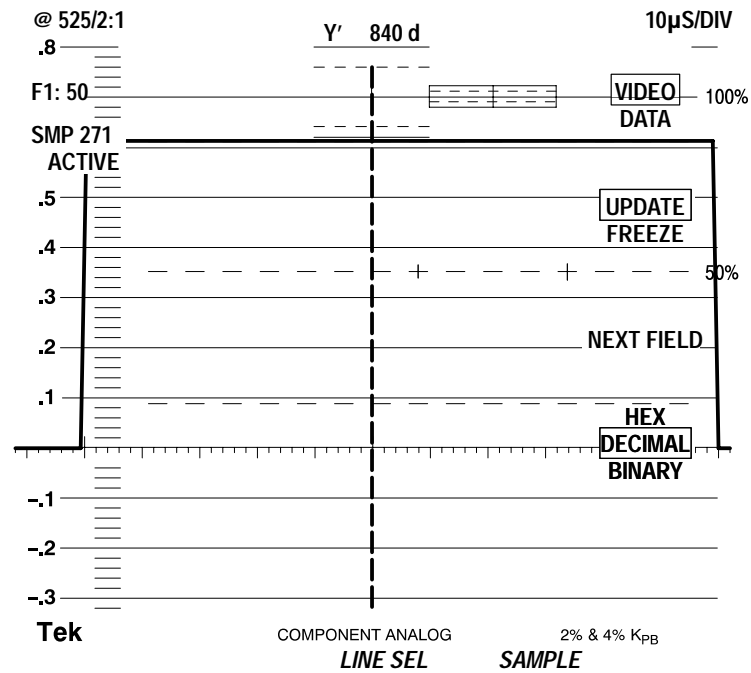

Figure 1-19: Video digital waveform

- d. Press the bezel button again to select the DATA display mode.
- e. Check that the display looks like the Data digital waveform display in Figure 1-20.

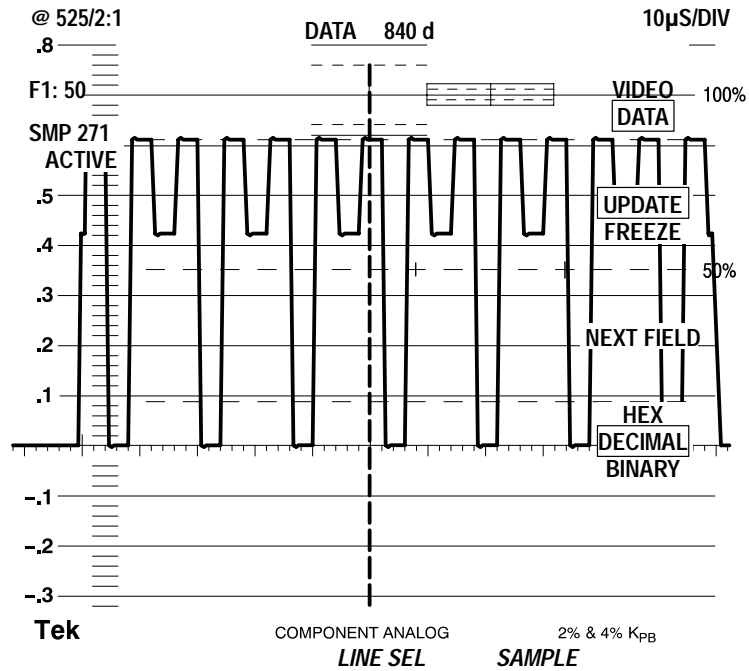

Figure 1-20: Data digital waveform

12. Check the Audio display mode. (WFM 601A only)

- a. Set the function generator for a sine wave at 1 kHz and 10 Vpk-pk or less amplitude.
- b. Press the ANALOG AUDIO button. The AUDIO button indicator should light.
- c. Check that the display looks like the Audio display in Figure 1-21.

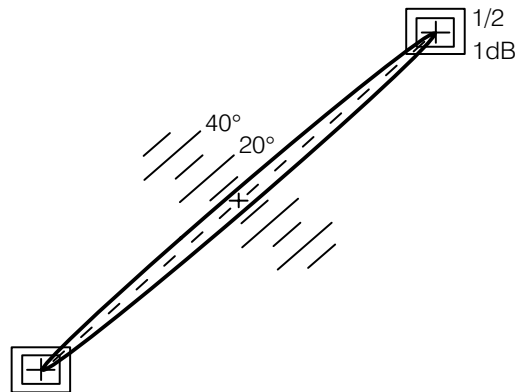

Figure 1-21: Typical Audio display with small phase error



Operating Basics

Functional Overview

This section provides an overview of the front-panel features and rear-panel connectors for the waveform monitor

Front Panel Overview

Figures 2–1 and 2–2 show the front panels of the three waveform monitors. A brief discussion of each feature follows the illustrations. For detailed information, refer to section 3, *Reference*.

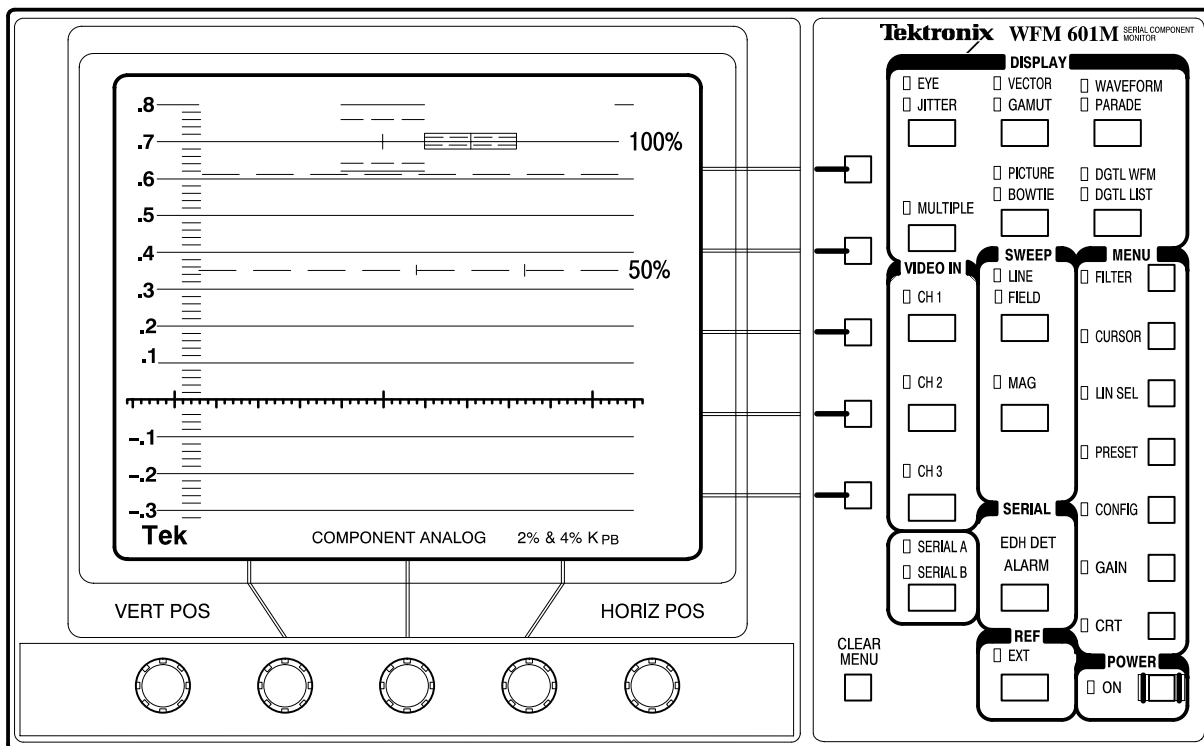
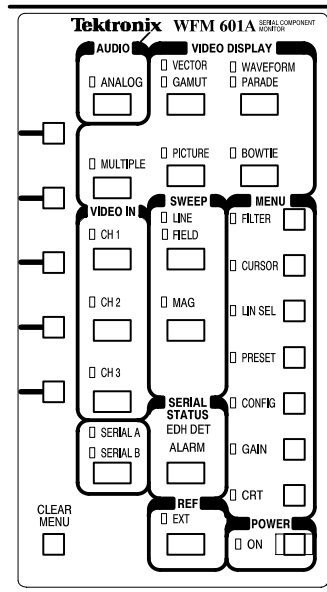
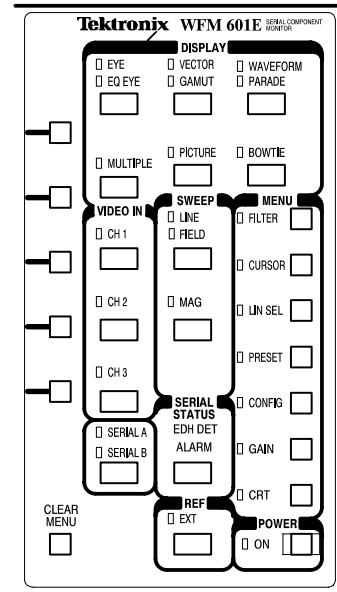

Figure 2–1: WFM 601M front panel



WFM 601A front panel



WFM 601E front panel

Figure 2–2: WFM 601A and WFM 601E front panels

DISPLAY and VIDEO DISPLAY Buttons

Six buttons in the DISPLAY or VIDEO DISPLAY area control the type of display. Most buttons represent two related types of displays. Press a button to select one of its two displays. Press the button again to select the other. When you select a display type, the indicator beside it lights up.

EYE. Displays the serial input signal as an Eye pattern display. For the WFM 601M, you can choose standard or equalized Eye displays with a bezel button.

EQ EYE . (WFM 601E only) Displays the input signal as an equalized Eye pattern display, which is useful when the signal has been degraded by long transmission lines.

JITTER. (WFM 601M only) Displays the peak-to-peak jitter measurement over a specified bandwidth. The display includes the demodulated jitter waveform for measurement.

VECTOR. Displays the component signals as either conventional Vector or Lightning mode. Vector mode plots the chrominance signals, P_b and P_r , against each other to show their phase and amplitude relationships. The Lightning mode shows amplitude and timing relationships between the luminance and chromi-

nance signals. The top of the display plots Y against P_b while the bottom plots Y against P_r .

GAMUT. Displays the video signal in Diamond or Arrowhead gamut displays. Diamond mode evaluates RGB signals for gamut limit violations. Arrowhead display plots Y versus chrominance magnitude to show adherence to composite gamut limits. A gamut error message appears at the lower-left when an RGB or Composite gamut error is detected. Turn this alarm on or off in the CONFIG menu.

WAVEFORM. Displays the video signal as voltage versus time. Any or all of the three channels can be displayed from a single video line.

PARADE. Displays up to three channels of the serial video signal in succession.

MULTIPLE. Allows two display modes to be active at the same time. The Waveform or Parade can be displayed with either Vector, Lightning, or Diamond.

PICTURE. Displays the video signal source. When Line Select is on, the selected line is highlighted to identify where it is in the video picture.

BOWTIE. Displays a bowtie test signal to determine timing differences between the three component signals, Y, P_b , and P_r . The external video source must generate a Bowtie test signal.

DGTL WFM. (WFM 601M only) Displays the displays digital word values as a waveform. The data values are not interpolated to generate the waveform.

DGTL LIST. (WFM 601M only) Displays the sequential data values in a list. Data may be in linear data sequence or as groups of four values as they appear in the multiplexed data stream: C_B , Y, C_R , Y'.

**AUDIO ANALOG
(WFM 601A Only)**

Displays the stereo analog audio input as a Lissajous pattern. The size of the opening in the pattern is relative to the phase error between the X and Y audio channels. The Lissajous pattern will take one of three general forms: a line, an ellipse, or a circle.

- Bezel Knobs** The center three knobs located below the CRT have multiple functions. Your selection of DISPLAY or MENU functions or items from on-screen menus determine the current function of each knob. A label adjacent to the knob indicates its current function. The outside knobs are permanently assigned to control vertical and horizontal trace position.
- Bezel Buttons** The five bezel buttons along the right side of the CRT have multiple functions. Your selection of DISPLAY modes, MENU functions, or on-screen items from the displayed menus determine the current function of each button. A label adjacent to each button indicates its current selection. The buttons either step through a list of two or more items or turn a function on or off.
- VIDEO IN** Allows you to turn on or off CH 1 (Y/R), CH 2 (P_B/G), and CH 3 (P_R/B) and to select the serial digital signal from input SERIAL A or B. At least one input and one channel are always on.
- SWEEP** The two Sweep buttons select the waveform monitor sweep rate and horizontal magnification.
- LINE / FIELD.** Toggles through four sweep rates: 1-Line (5 μ s/div), 2-Line (10 μ s/division), 1-Field, and 2-Field. Selections are limited in some display modes.
- MAG.** Provides horizontal magnification of waveform signals. Use the Horizontal Position bezel knob to move left or right on through the waveform.
- SERIAL** Displays a status screen providing EDH error statistics and format error reporting, including ANC data errors and line/field length errors. This area includes two indicators.
- EDH DET.** Lights up when the incoming serial digital signal has the SMPTE RP165 specified Error Detection and Handling (EDH) signal.
- ALARM.** Lights up when a serial video data or format error occurs or when a serial signal is not detected.
- REF (Reference)** Selects either internal serial digital or external composite video input for the instrument synchronization reference.
- MENU** Provides access to configuration and measurement functions that affect the DISPLAY mode. Press a MENU button to display that menu and enable the

associated functions. Press the button again to exit the menu and disable the function.

POWER Puts the waveform monitor into the standby or operational state.

CLEAR MENU Turns off the MENU function readouts without affecting the menu settings. Also, provides access to alternative displays in some display modes.

Using the Menus

The instrument has a set of front-panel selectable MENU buttons that call up CRT readout menus. These menus operate in conjunction with the five bezel buttons along the side of the CRT and the three knobs directly beneath it. See Figure 2-3.

Enabled menu selections are surrounded by a rectangle to indicate that they are active.

Pressing the CLEAR MENU button turns off the menu readout while leaving the functions associated with the current Display mode.

Pressing a MENU button when its menu is displayed turns off both the menu readout and, in most cases, disables the function. By selecting Line Select, Cursor, Filter, or Gain, the last settings are returned. For example, if X5 was active when you last used the Gain menu, returning to the Gain menu restores X5 gain.

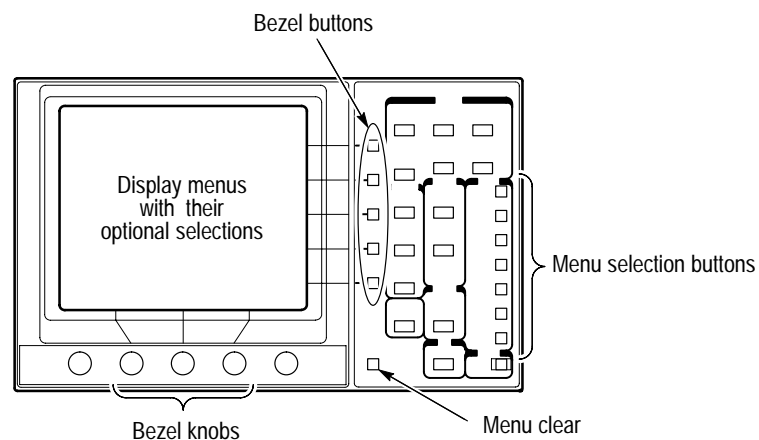

Figure 2-3: Elements of the waveform monitor menu controls

Rear Panel Connectors

Figure 2–4 shows the rear panel of the waveform monitor. A brief discussion of each connector follows the illustration.

Power Connector

The waveform monitor is designed to operate from a single-phase power source with the neutral conductor at or near earth ground. Only the line conductor is fused for over-current protection. A protective ground connection through the grounding conductor in the power cord is essential for safe operation.



WARNING. Dangerous potentials are present on the Power circuit board. Do not connect power to the waveform monitor if it is not enclosed in a prescribed cabinet.

The waveform monitor operates from an AC line frequency of 50 and 60 Hz, over the range of 90–250 VAC, without the need for configuration. Refer to *Appendix A: Specifications* for additional information on power and environmental requirements.

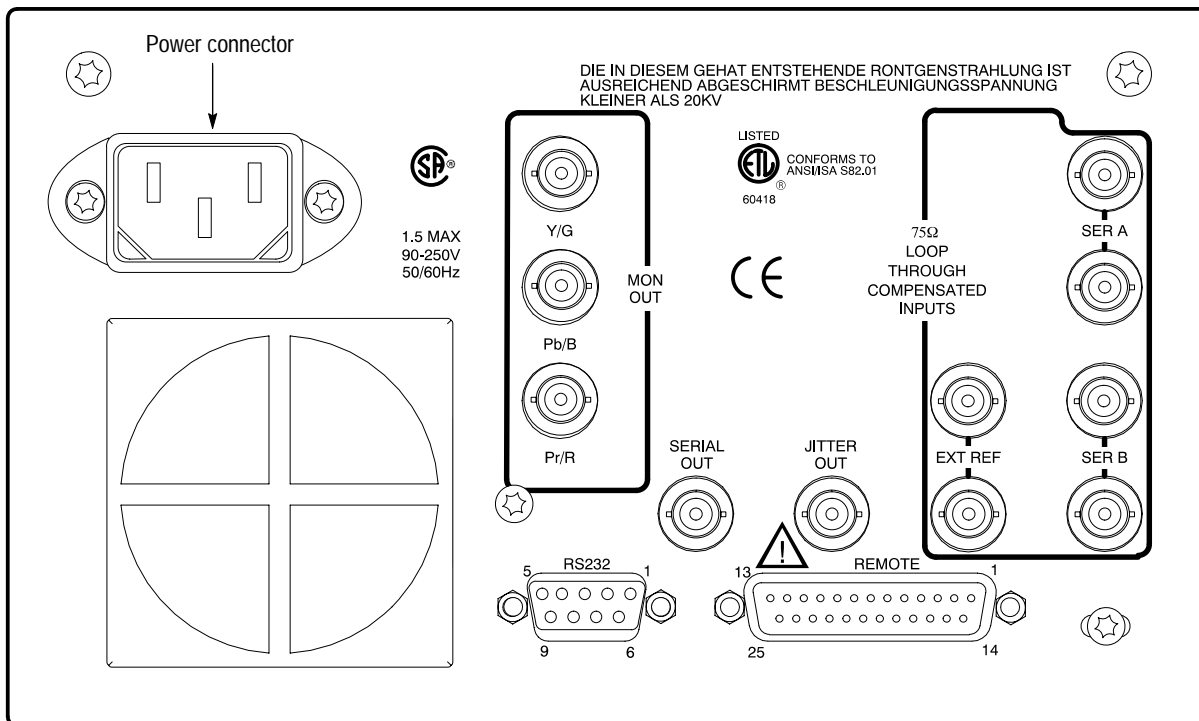

Figure 2–4: Rear panel of the waveform monitor

Loop-Through Inputs

There are three passive loop-through inputs located on the rear panel. All are compensated for 75 Ω impedance and require proper termination at one end of the loop-through connector or at the receiver in a monitored system.

SER A and **SER B**. Provides for connection of two 270 Mb serial component data signals. These inputs have minimal impact on the monitored serial data path.

EXT REF. Provides for connection of an external synchronization signal such as black burst or composite video.

Coaxial Outputs

Five rear panel connections drive signals into a 75 Ω environment.

MON OUT (Y/G, P_B/B, P_R/R). Provides three 75 Ω component signal outputs to drive a component picture monitor. You can set the output format to YP_BP_R or GBR. Invalid input signals cause a blinking highlight of the monitor display at the line where the error occurs. This gamut error highlight or “bright-up” signal is present on the Y (or G) output and is controlled in the CONFIG menu.

SERIAL OUT. Provides a reclocked version of the selected signal input (SER A or SER B).

JITTER OUT. (WFM 601M only) Provides a 75 Ω output signal from the jitter demodulator. The Jitter high-pass filter (JITTER HPF) selection does not affect this signal. You can view the jitter waveform on the waveform monitor using the JITTER display mode.

Multi-Pin Connectors

Two multi-pin connectors provide control using a PC or other controller. Refer to *Appendix B* for pin assignment information for these connectors.

RS-232. This 9-pin subminiature D-type connector provides a serial interface for remote control and calibration.

REMOTE. This 25-pin subminiature D-type connector provides limited remote control functions.



Reference

Reference

This section provides detailed information on the waveform monitor functions. The topics are organized alphabetically. Most topics are named after the front panel labels and button names.

Audio Display (WFM 601A Only)

The Audio display allows you to measure stereo audio phase errors of 20 kHz analog stereo audio signals. Connect the audio signals to the Remote Connector described in Appendix B on page B-2.

Correct phasing between two audio channels is quickly verified by the degree of separation in the pattern shown on the display. Amplitudes are verified by the direction of the pattern's axis.

Audio amplitude and phase is monitored using a calibrated X/Y Lissajous display. Using this display you can verify that the program audio will be properly reproduced on both monaural and stereo receivers.

Lissajous Patterns

Any oscilloscope, including a vectorscope, that has identical X and Y amplifiers can make accurate stereo audio phase measurements. When identical signals of equal amplitude are input, the display pattern produced will be a Lissajous pattern. The opening of the Lissajous pattern is relative to the phase error between the signals. The remainder of this section discusses some of the Lissajous patterns generated by the waveform monitor.

Figure 3-1 depicts an input audio signal from one channel. The figure on the left depicts input from the X channel only, which produces a line pattern along the X axis of an XY plot. Similarly, a line pattern along the Y axis of an XY plot indicates an input audio signal from the Y channel only, as shown in the figure on the right.

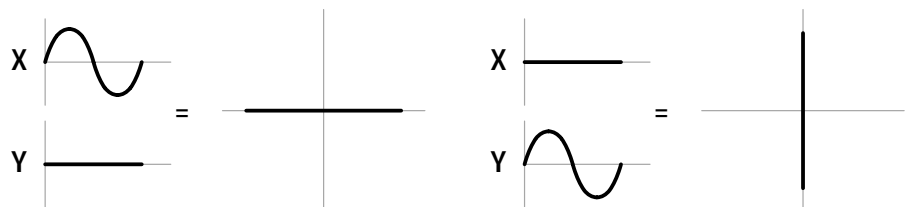

Figure 3-1: A signal from one channel only

Figure 3–2 depicts an input audio signal in which the X and Y channels are in perfect phase and have equal amplitudes.

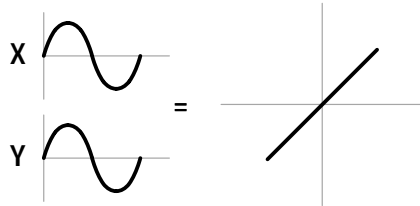

Figure 3–2: X and Y signal in phase with equal amplitudes

Figure 3–3 depicts an input audio signal in which the X and Y channels are out of phase by some amount but have equal amplitudes. The pattern is an ellipse rather than an line, which indicates the signals are out of phase. The axis of the ellipse lies terminates in the target boxes, which indicates that the amplitudes are equal.

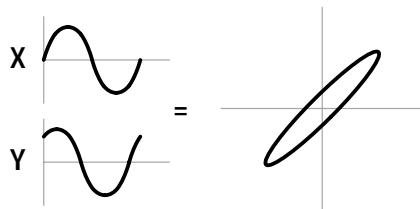

Figure 3–3: Signals out of phase with equal amplitudes

Figure 3–4 depicts signals out of phase with unequal amplitudes. The figure on the left shows a signal in which the X channel amplitude is greater than the Y channel. The figure on the right depicts a signal with a larger Y channel amplitude.

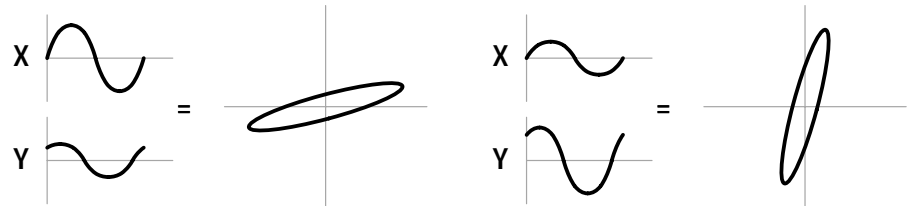

Figure 3–4: Signals out of phase with unequal amplitudes

Figure 3–5 depicts an input audio signal in which the X and Y channels are reversed (reversed polarity) with equal amplitudes.

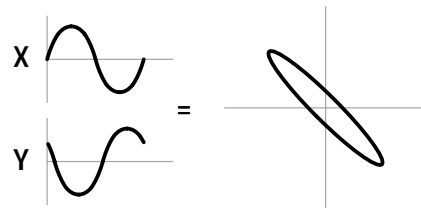

Figure 3–5: Signals with reverse polarity and equal amplitudes

If the phase error between the X and Y channels is exactly 90 degrees and the amplitudes are equal, the pattern of the audio signal input is a circle. See Figure 3–6.

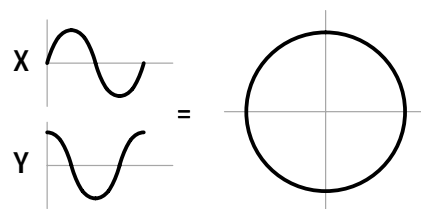

Figure 3–6: Signals with a phase error of 90 degrees and equal amplitudes

Measuring Phase Error

The electronic graticule of the Analog Audio Display has scales for measuring stereo audio phase and amplitude errors. The dashed diagonal line is the measurement axis for errors less than 90 degrees and is terminated in amplitude targets that correspond to the length of the X and Y axes. The boxes surrounding the crosshairs are equal to amplitude errors of 1/2 and 1 dB, respectively.

Phase error is measured as degrees of phase shift and is relative to the minor axis of the ellipse pattern displayed on the CRT. To determine the phase error, read the value of the electronic graticule where the ellipse is tangent to the scale of the electronic graticule.

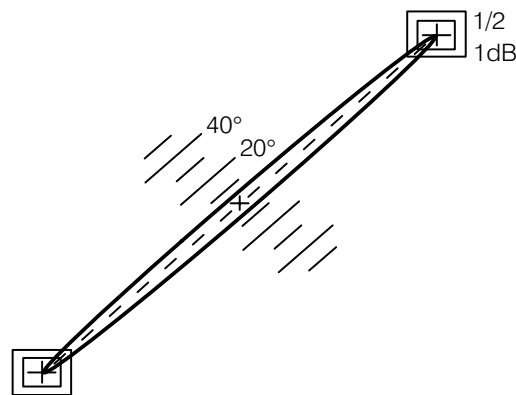

Figure 3-7: Typical Audio display pattern with small phase error

Adjusting the Audio Gain

The waveform monitor has four graticule calibrations available: 0, +4, +8, and +12 dBu. To adjust these levels use the following procedure.

1. While in the Audio display mode, press the GAIN menu button.
2. Press one of the bezel buttons to select the appropriate calibration level.

Bowtie Display

The Bowtie display evaluates the relative amplitude and timing between the three video channels. This display requires a special test signal from the monitored source. See Figure 3–8. The Tektronix TG 2000 Waveform Generator can produce a bowtie signal with 20 ns time marks, which aid in signal evaluation. The signal is a 500 kHz sinewave on CH 1 (luminance) and 502 kHz sine waves on CH 2 (Pb) and CH 3 (Pr).

The display is made up of two separate waveforms as shown in Figure 3–8. The left waveform always compares CH 1 to CH 2. The right waveform always compares CH 1 to CH 3.

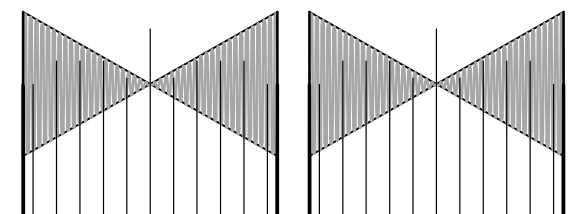

Figure 3–8: Typical Bowtie display on the waveform monitor

Timing Measurement

The timing measurement is based on alignment of the center marker and the null point at the center of the waveform. The generator provides a center marker, which is centered on the null point when interchannel timing is correct. A shift of the null to the left or right indicates a difference in the relative timing. If the null shifts two full time markers, the relative timing error between channels would be 40 ns. If the null is to the left of the center marker, the color difference channel is advanced relative to the luminance channel. When either of the nulls is shifted to the right, that color difference signal is delayed relative to the luminance channel. In Figure 3–9, the chrominance channel—CH 3 (Pr)—is advanced relative to the luminance channel by 20 ns.

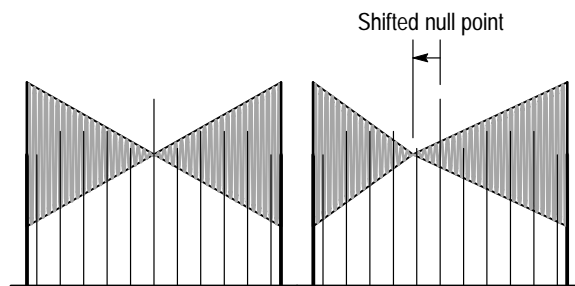

Figure 3–9: Bowtie waveform showing a timing error in CH 3

Although you can use Waveform or Lightning displays to determine channel timing, the Bowtie method provides better resolution of channel timing and is the easiest to use.

Relative Gain Check

The bowtie measurement provides a method to determine whether the relative channel gain is correct. If the gains are not equal, the center null point will not be a complete null. Figure 3–10 shows a Bowtie display with an incomplete null in the right waveform. If the gain error is in CH 1, neither waveform has a complete null. If CH 2 gain is off, the left waveform will not null completely, but the right one will. If the gain is off for CH 3, as in Figure 3–10, the left waveform will be normal and the right one will not reach a complete null.

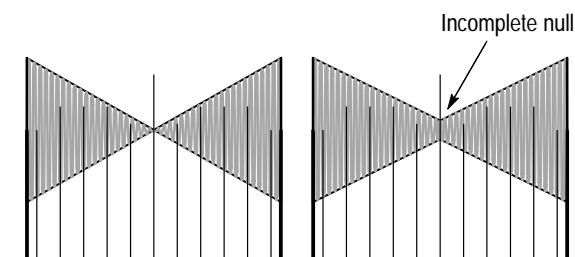

Figure 3–10: Bowtie waveform showing gain error in CH 3

Calibration

Instrument gain may require adjustment for special monitoring applications or to ensure the best precision for cursor or graticule signal measurements. Follow these procedures to set the vertical and horizontal gain.

Setting Vertical Gain

1. Press the WAVEFORM/PARADE button to select the Waveform display.
2. Press the CONFIG menu button and use the bezel knob to select the CALIBRATE submenu. Press the bezel buttons to set CAL SIG on and GAIN CAL on.
3. Use the VERT POS control to place the calibrator signal between the 0 V reference and 0.7 graticule lines. The amplitude of the calibration signal is exactly 700 mV.
4. If the RESET V CAL readout is on, press the adjacent bezel button to turn it off. Pressing the RESET V CAL bezel button reinstates the gain setting established at the last calibration.
5. Check to see that the calibrator signal is now displayed at exactly 700 mV. If the gain is off, adjust the gain for exactly 700 mV with the V CAL bezel knob. Press the GAIN CAL button if the V CAL knob is not available.

Setting Horizontal Gain

1. Press the Waveform/PARADE button to select the Waveform display.
2. Press the CONFIG menu button and use the bezel knob to select the CALIBRATE submenu. Press the bezel buttons to set CAL SIG on and GAIN CAL on.
3. If the RESET H CAL readout is on, press the adjacent bezel button to turn it off. Pressing the RESET H CAL bezel button reinstates the gain setting established at the last calibration.
4. Press the SWEEP LINE/FIELD button to select the 2 Line sweep mode (10 μ s/div) and check for one full cycle per major division.
5. If the gain is off slightly, adjust the horizontal gain with the H CAL bezel knob. If the H CAL knob is not available, press the GAIN CAL button.

Configure Menu

The Configure menu provides configuration selections for all display modes and some external signals. Press the CONFIG MENU button at any time to enter the Configure menu. Figure 3–11 shows a sample Configure menu and the bezel knob used to select from the list of Configure menus. Figure 3–12 provides a map of all Configure menu functions.

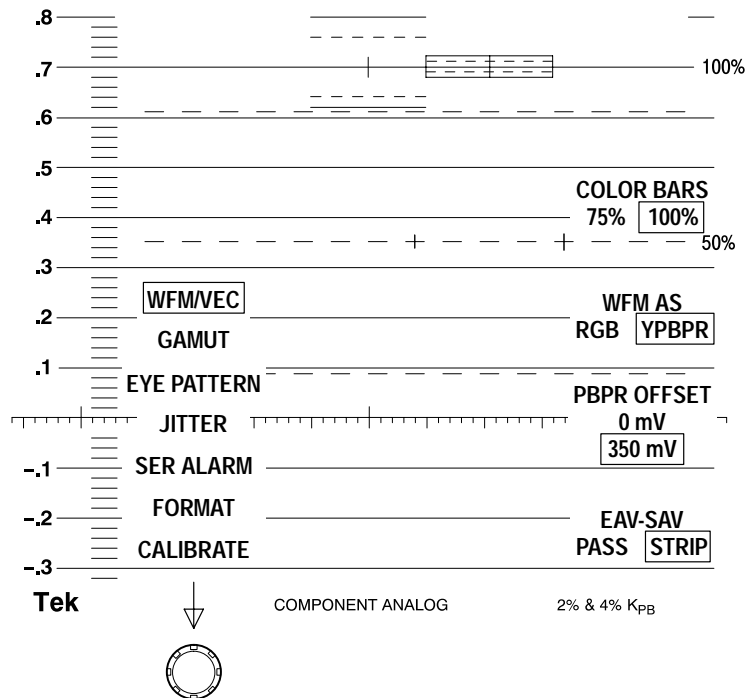

Figure 3–11: Configure menu for WFM/VEC showing the selection knob

Turning the knob causes a selection box to scroll through the menu list. The selections assigned to the bezel buttons change as you scroll through the list of Configure menus. Press the CONFIG button again to remove the Configure menu.

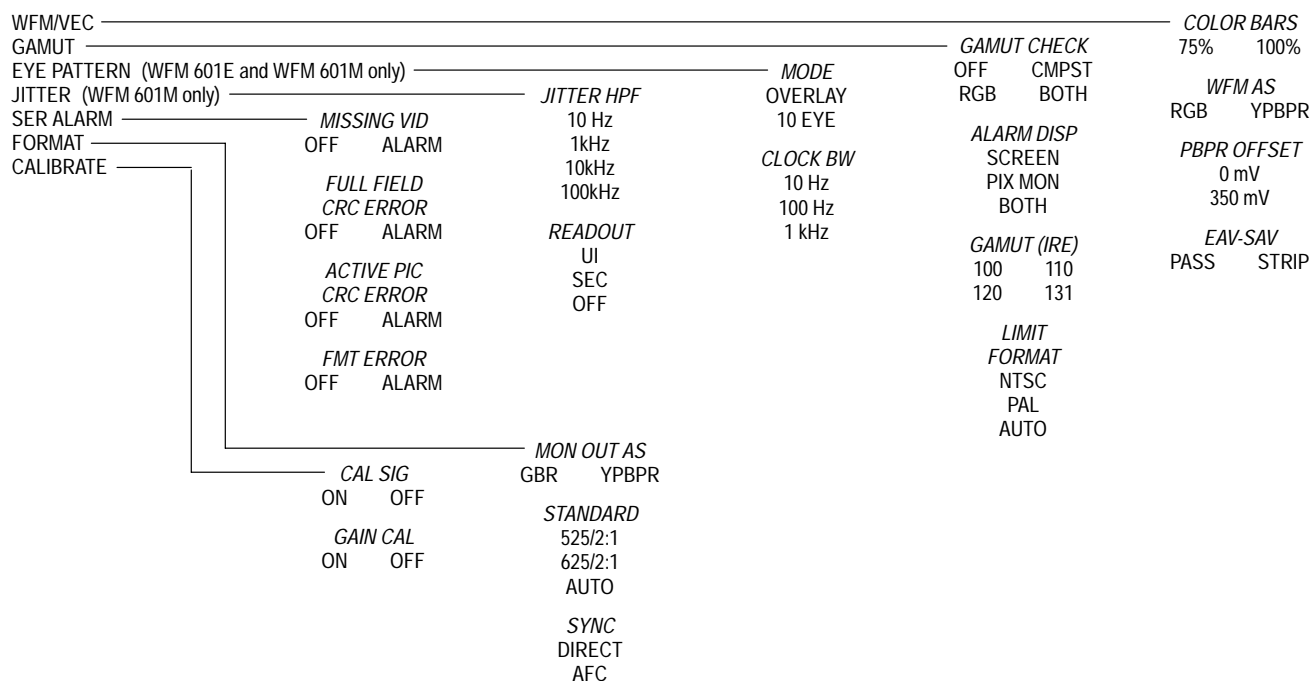

Figure 3–12: Map of functions available in the Configure menu

Configure Menu Description

The following list describes the items in each Configure menu.

WFM/VEC. Contains choices for the Waveform, Parade, Vector, and Lightning video displays.

- **COLOR BARS.** Selects either 75% or 100% graticules for the Lightning and Vector modes.
- **WFM AS.** In Waveform or Parade modes, determines if channels 1, 2, and 3 are displayed in their native Y, P_b, P_r format (YP_bP_r) or transcoded to R, G, B (RGB). WFM AS does not affect the picture monitor output signal (MON OUT).
- **PBPR OFFSET.** Allows adding a 350 mV positive offset to the P_b and P_r channels to facilitate comparison with the Y channel. Does not affect the transcoded RGB display or the picture monitor out signal.
- **EAV-SAV.** Determines what data is passed to the D/A converters. In Strip mode, only digital signals between the SAV and EAV (start and end of active region) sync words are passed to the D/A converters and subsequently to the display and the picture monitor output. In Pass mode all digital data is sent to the converters.

GAMUT. Configures conditions and error indicators for the gamut error alarm.

- **GAMUT CHECK.** Determines whether RGB, Composite (CMPST), or both types of gamut errors trigger the gamut alarm. RGB indicates when the R, G, or B signals are less than 0 mV or greater than 700 mV. CMPST indicates when the sum of luminance and peak chrominance exceed the level selected with GAMUT (IRE). Use ALARM DISP to determine the indicator of the gamut alarm.
- **ALARM DISP.** Determines how the gamut alarm is indicated. In SCREEN mode, a gamut error message appears in the lower left of the CRT. In PIX MON mode, the portion of the video picture that exceeds gamut, blinks in a highlighted or bright-up mode on the picture monitor output.
- **GAMUT.** Sets the level used for the CMPST gamut alarm. For NTSC, the levels are 100, 110, 120 and 131 IRE. For PAL, the levels are 700 mV and 950 mV. Use GAMUT CHECK to pick the CMPST alarm.
- **LIMIT FORMAT.** Determines if the gamut limit check is for PAL or NTSC format signals. AUTO mode automatically determines the input format.

EYE PATTERN. Selects the display mode and attenuation of low-frequency jitter for the EYE and EQ EYE display modes.

- **MODE.** Selects between OVERLAY and 10-EYE trigger modes. Overlay displays all bits of a serial word at each eye location. The 10-EYE mode displays all ten bits of the serial signal at ten fixed locations.
- **CLOCK BW.** Selects between 10 Hz, 100 Hz, and 1 kHz filters to suppress low-frequency jitter.

JITTER. Configures the Jitter measurement with a high pass filter and the units of the readout.

- **JITTER HPF.** Selects from high pass filters 10 Hz, 1 kHz, 10 kHz, and 100 kHz. The selection appears in the jitter readout box and in the upper right corner of the CRT, just below the horizontal deflection factor.
- **READOUT.** Determines whether the jitter measurement is in the units UI (unit intervals) or seconds or if the readout is off.

SER ALARM. Selects which events cause the Alarm indicator to light. The front-panel Alarm light can be activated by up to four different serial video conditions. Press the adjacent bezel buttons to turn these alarms on or off.

When an alarm condition occurs, the Alarm light stays on for a minimum of one second. If selected alarm conditions occur at a frequency greater than once per second, the Alarm light stays on continuously.

When any of the following conditions are enabled and a condition occurs, the alarm indicator turns on:

- **MISSING VID.** The input serial signal level drops below a preset threshold (determined by the serial receiver).
- **FULL FIELD CRC ERROR.** The transmitted cyclical redundancy checksum (CRC) does not match the actual CRC for the last video field.
- **ACTIVE PIC CRC ERROR.** The transmitted CRC does not match the actual CRC for the last active picture region.
- **FMT ERROR.** A serial format error occurs.

FORMAT. Selects the format of the picture monitor out signal and the scanning standard expected by the waveform monitor.

- **MON OUT AS.** Configures the analog component picture monitor out signal as either Y, P_b, P_r, (YP_bP_r) or as GBR. Composite sync is added to the Y or G channel.
- **STANDARD.** Selects the scanning standard, from either 525/2:1 or 625/2:1, that the waveform monitor expects at the SER A and B inputs. This choice affects the monitor sweep rates and the line selector. In AUTO mode, the monitor selects either 525 or 625 line operation based on the detected field rate (60 Hz or 50 Hz).
- **SYNC.** Selects either Direct or AFC synchronization of the internal timing. The Direct mode uses the 27 MHz word clock as extracted from the serial digital signal. This mode passes any signal jitter on to other internal operations and to the MON OUT video signals. The AFC mode uses a phase-locked loop circuit to produce a stable clock. The phase-locked loop averages small-phase differences in the clock. The AFC mode is best in most situations. Use the Direct mode when large, low-frequency jitter is present in your system.

CALIBRATE. Allows minor adjustment to the vertical and horizontal gain calibration prior to making amplitude measurements. To adjust gain, you need a 700 mV, 100 kHz signal. Use a known external reference signal or the internal calibrator signal. Selections for the CALIBRATE menu are only present when in the Waveform or Parade display modes.

- **CAL SIG.** Turns on or off the internal 700 mV calibrator signal. The calibrator signal is synchronized in order to provide an accurate 100 kHz timing standard. If the calibrator signal varies significantly from 700 mV when RESET V CAL is *not* visible, then the waveform monitor may require calibration.
- **GAIN CAL.** Enables or disables the V CAL and H CAL controls. The V CAL knob adjusts vertical gain and the H CAL knob adjusts the horizontal gain. To return the gain to its original calibrated setting, press the RESET V CAL or H CAL bezel buttons.

In addition, the following software version information appears:

- **Software Version Number.** The lower right corner of the CRT shows the version number for the instrument software preceded by a “V”.
- **Coprocessor Code Version.** The lower right corner of the CRT shows the version number of the serial coprocessor code preceded by a “C”.

CRT Settings

The CRT menu provides control of trace parameters and readout intensity. To access the CRT menu at any time, press the MENU CRT button. Press the top bezel button to access the Display, Readout and Trace controls. Use the assigned bezel knobs to adjust the display. You can control the following functions from the CRT menu:

- **Focus.** Sets the sharpness of the waveform trace.
- **Scale.** Sets the intensity of the side lights that illuminate the etched graticule.
- **Intensity.** Sets the trace intensity or brightness separately from the readout.
- **Readout Intensity.** Sets the readout intensity or brightness.
- **Trace Rotation.** Adjusts the rotation of the trace.

How to Recover from Minimal Readout Intensity

Readout intensity can be turned below the minimum viewing level, which makes all CRT menus disappear. If this happens, press the CRT menu button and note that the menu comes up at a reduced intensity. Pressing the top CRT bezel button once moves the cursor to READOUT and reduces the intensity again. At this

point, turn the bezel knob next to the HORIZ POS knob clockwise to increase the readout intensity.

Press the CRT button to exit the CRT menu.

Cursors

Cursors allow you to measure the amplitude or time difference between waveform features. Cursors usually provide better measurement resolution than is possible measuring against the etched graticule. Press the CURSOR MENU button to display the Cursor menu.

Cursor Menu Features

The Cursor menu allows you to choose Voltage Cursors, Time Cursors, Markers, or both Voltage and Time cursors. When Voltage and Time cursors are active, the three bezel knobs control cursor 1, cursor 2, and cursor tracking. The difference in the settings of cursor 1 and cursor 2, is reported with CRT readout as ΔV or ΔT . In the Both mode (V+T), use the CONTROL bezel button to alternate between voltage and time cursor control. Tracking locks the cursors at their current separation and lets you move them together.

Markers provide adjustable screen reference points with no associated readout. Markers may be positioned vertically, but not horizontally. The three markers are identified by the type of dashed lines:

- Mark 1 has long dashes.
- Mark 2 has double dashes.
- Mark 3 has short dashes.

Pressing the CLEAR MENU button removes the cursor selections, but the cursors, difference readout (voltage or time), and control assignments remain active and on screen. To restore the Cursor menu, press the CURSOR menu button again. To turn off the cursors, press the CURSOR button when the Cursor menu is displayed (two presses when the Cursor menu is not displayed).

Variable Gain and Sweep with Cursors

The Cursors are tied to the trace scaling. Hence, cursor measurements are accurate with Gain set to X5, X10, or Variable Gain.

The various sweep modes are compatible with the Time Cursors. You can make Time Cursor measurements in any of the Sweep modes: 1-Line, 2-Line, 1-Field, or 2-Field. You may need to brighten the cursors and the trace by pressing the CRT MENU button and adjusting the intensity.

Time Cursors measurements are possible with MAG on, though both cursors may be off screen. The measurements are accurate, even though you cannot see the

Time Cursors. Use the HORIZ POS knob to pan left or right to the cursor locations.

Digital List (WFM 601M Only)

The Digital List display lists the data values in sequence as they occur in the digital component video signal. Press the DGTL WFM/DGTL LIST button to enter the Digital List mode. Figure 3–13 shows an example of the Digital List display. You can use the data cursor, assigned to a bezel knob, to scroll through the data. The location of the data cursor in the Digital List display is correlated with the data cursor in the Digital Waveform and Parade display modes.

Video/Data Selection

The Video/Data bezel button chooses between two displays. Figure 3–13 shows the DATA mode. Figure 3–14 shows the VIDEO mode with the same data values as those in Figure 3–13. The VIDEO mode groups the samples in the order in which they occur in the data stream, C_bY_CY'. The label above the grouped list indicates this order.

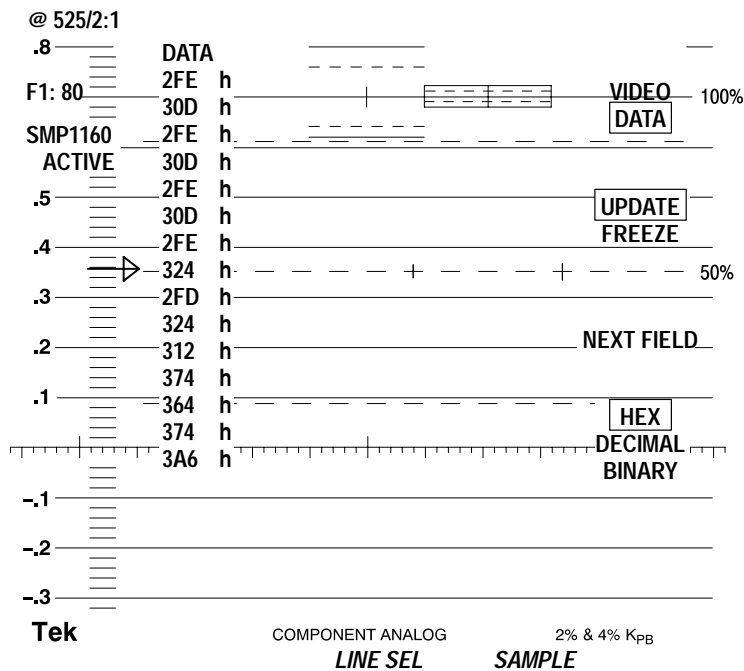

Figure 3–13: Example of the Digital List display

Data Format Press the fourth bezel button to select the base used for displayed data from hexadecimal (h), decimal (d), or binary (b). The characters (h, d, or b) following the data indicates its base.

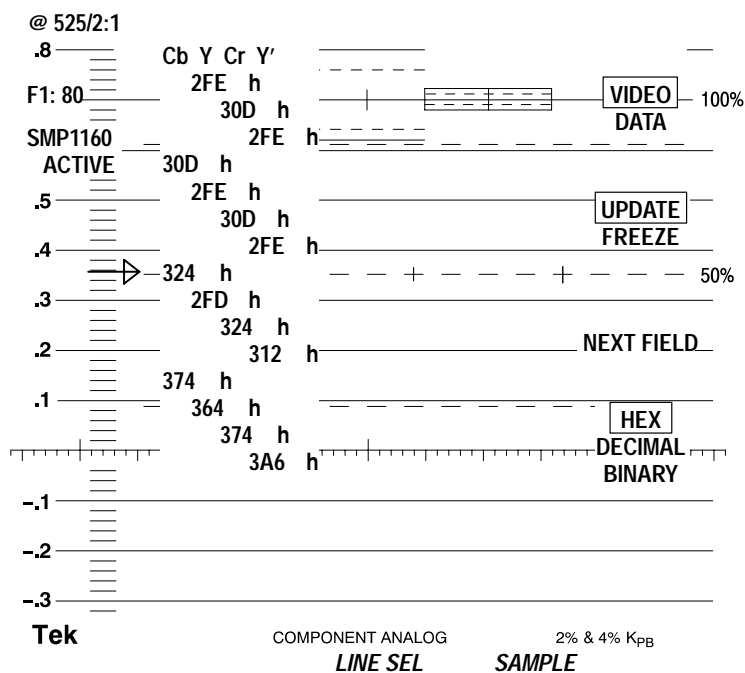

Figure 3-14: Data List display mode in the Video mode

Freeze/Update Press the second bezel button to select between active, video data and frozen data. Frozen data is not updated with current values from the video data stream. The Freeze mode stores six lines with three lines from each field. Use the Next Field bezel button to switch between fields.

Line Select Settings In the Digital List display, Line Select is set to Sample by default. Use the bezel knobs labeled LINE and SAMPLE to select video lines and samples within a line. The current field and line appear at the upper left on the CRT. Use the Next Field bezel button to alternate between fields in a frame. The Sample knob scrolls to the end of the line then returns to the beginning of the line.

Digital Waveform (WFM 601M Only)

The Digital Waveform display shows the component data samples as a waveform. Press the DGTL WFM/DGTL LIST button to enter the Digital Waveform mode. Figure 3–15 shows an example of the Digital Waveform display. You can use the data cursor, assigned to a bezel knob, to scroll through the data waveform. The data cursor remains centered while the data scrolls by. The location of the data cursor on the Digital Waveform display is correlated with the data cursor in the Digital List Display and with the sample select indicator or “blivit” in the Waveform and Parade Displays. For more information on the data cursor, refer to Line Select on page 3–39. The value of the current sample on each waveform appears above the waveform. The character (h, d, or b) following the value indicates its base.

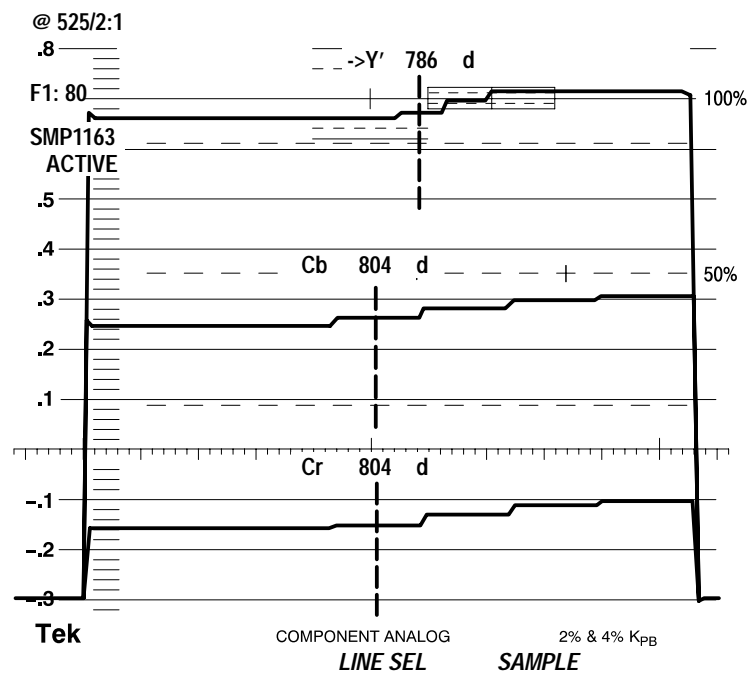

Figure 3–15: Digital Waveform display in the VIDEO mode

Video/Data Selection

Use the VIDEO/DATA bezel button to select the format of the digital waveform. Figure 3–15 shows the VIDEO mode and Figure 3–16 shows the DATA mode. Note the DATA label at the top of the data cursor in Figure 3–16.

The VIDEO mode displays the three video component channels, $Y C_b C_r$, as separate waveforms. Any or all of the three channels may be displayed at one time. The channels are correctly time aligned so the data cursor shows the current sample values for each. Note that Y and Y' samples are interleaved to create the CH 1 waveform. As you move the data cursor through the CH 1 data, the label

will switch between Y and Y'. The symbol “->” indicates the currently selected sample. The offset or broken data cursor seen in Figure 3-15 indicates that the Y' sample is selected and it is not aligned (nonco-sited) with the C_b and C_r channels. The Y sample is aligned or co-sited with C_b and C_r channels and its data cursor appears in line. Use the Video mode when selecting samples in the active picture area.

The DATA mode displays the samples in sequence as they are received (Cb,Y,Cr,Y'). Use the Data mode to view sync words (EAV and SAV) and ancillary data.

Output Monitor Signals

The data cursor creates intersecting horizontal and vertical highlighted (or bright up) lines on the analog video output to indicate where in the video signal the data cursor is located. When you move the data cursor to the end of a line, the output picture shifts to show you the horizontal sync region. Likewise, when you move to the beginning or end of a frame, the vertical sync region shifts to the center of the screen. As you scroll through line samples, watch the location of the highlighted line on the output monitor. By doing so, you can correlate changes in the video signal with changes in the digital data values. To use the cross-hair cursor in the horizontal and vertical blanking regions, set EAV-SAV to PASS in the Configure WFM/VEC menu.

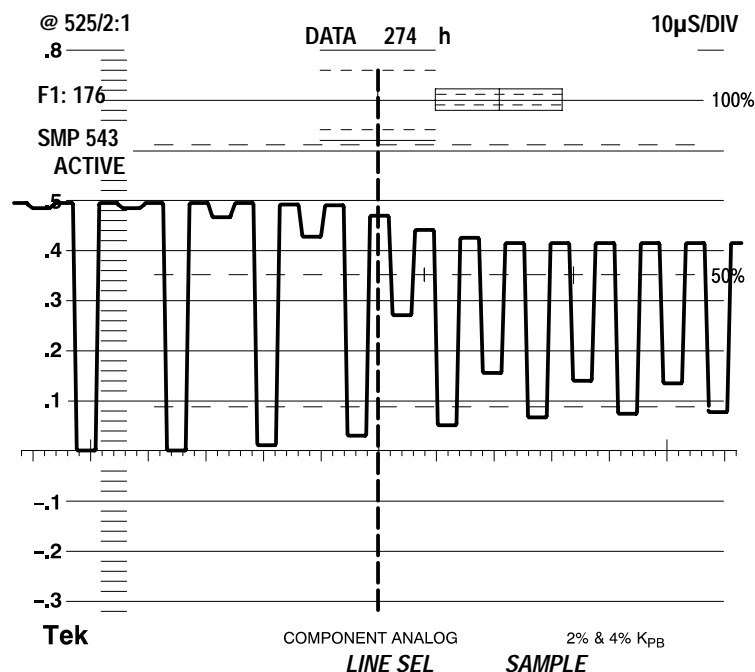

Figure 3-16: Digital Waveform display in DATA mode

Gain Interactions

Use the GAIN MENU function to magnify the vertical gain of a single channel by X5 or X10. Figure 3–17 shows CH 1 with X5 gain. Note the data cursor readout is for the “Y” channel with a value of 868 decimal.

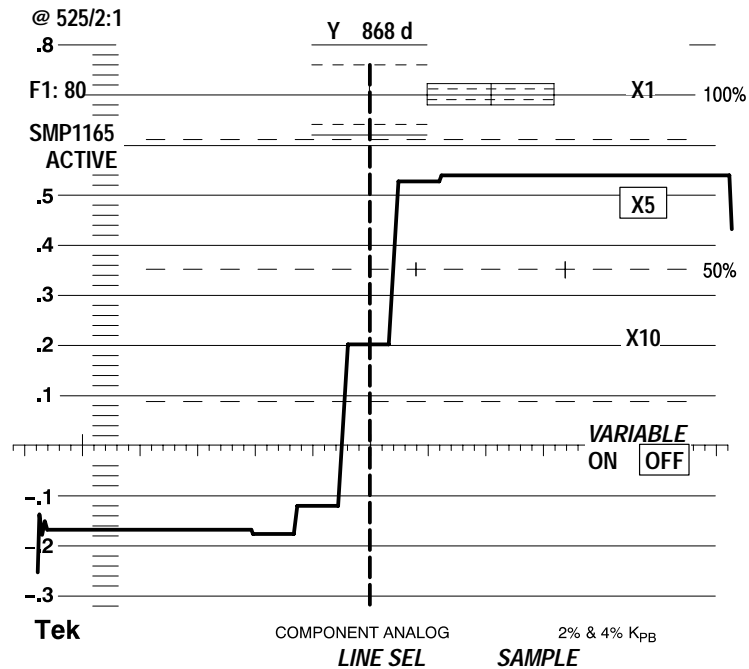

Figure 3–17: Digital Waveform display showing X5 gain on CH 1 (Y) waveform

Line Select Settings

Choosing the Digital Waveform display forces Line Select to the Sample mode. Line Select in the Sample mode assigns two bezel knobs to select video lines and samples within a line. The current field and line readout appear at the upper left on the CRT. Press the Next Field bezel button to alternate between fields in a frame. The Sample knob scrolls to the end of the line then returns to the beginning of the line.

Eye Display (WFM 601E and WFM 601M Only)

The Eye pattern display presents a voltage-versus-time waveform composed of multiple sweeps of the serial bit stream. You can measure the amplitude, rise time, aberrations, and jitter of the serial signal using the Eye pattern display. Select either the Serial A or B input for display and measurement. You can also choose to display the raw signal data (FLAT) or perform receiver equalization (EQ EYE) on the signal before display.

Use the cursors to measure parameters of the Eye display. Refer to page 3–22 for instructions on using the cursors to measure the Eye display.

EYE and EQ EYE Modes

The EYE and EYE EQ modes allow measurement in short and long transmission line environments, respectively.

On the WFM 601E, press the EYE/EQ EYE button to select the EYE or EQ EYE modes.

On the WFM 601M, press EYE/JITTER button to select the EYE mode. Press the lower bezel button to alternate between the EYE and EQ EYE modes. If the EYE/EQ EYE selection is not visible when the EYE display is active, press the CLEAR MENU button.

The EYE mode directly displays the serial signal applied to the rear panel loop-through input. This mode is best for directly monitoring a serial digital source or a short length of cable. When monitoring a signal near the end of a long cable run, the EYE mode might show what appears to be a band of noise. Use the EQ EYE mode to restore the signal shape and amplitude before display.

The EQ EYE mode is best used to measure signals degraded by transmission through a long cable. The EQ EYE mode applies receiver equalization to the serial signal to restore it. Because equalization enhances the signal and causes signal peaking, it is best used to check signal continuity. You should regard EQ EYE display measurements as uncalibrated and merely qualitative.

For the best measurements, use the EYE mode whenever possible. Use EQ EYE when the EYE mode fails to provide a useful signal.

Clock BW Filters

Both EYE pattern displays can attenuate low frequency jitter using one of three clock-recovery filters. Select from the 10 Hz, 100 Hz, and 1 kHz filters. Use these Clock BW filters to separate the medium and high frequency jitter from low frequency jitter. The filter frequencies indicate the –3 dB point. To access the filters, press the CONFIG button and select the EYE PATTERN menu. The 10 Hz and 1 KHz filters allow jitter measurements according to the SMPTE RP-184 standard.

The selected clock bandwidth filter appears in a readout field directly below the horizontal deflection factor.

Trigger Modes Two trigger or sweep modes are available with the Eye display: OVERLAY and 10-EYE.

OVERLAY. In OVERLAY mode, all bits of a serial word are overlaid at each eye location. Because numerous transitions for the data bits are overlaid, each eye crossing shows the timing jitter in the video system. Figure 3–18 shows the Overlay Eye display. Approximately three eyes are displayed and the horizontal scale is 1 ns/div.

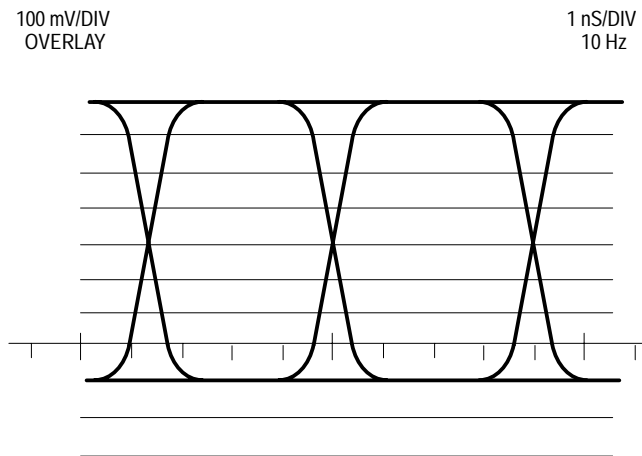

Figure 3–18: Overlay Eye display

10 EYE. In 10-EYE mode, every tenth bit of the serial signal appears at a fixed location on the display. Figure 3–19 shows the 10-EYE mode. Approximately 10 eyes are displayed per horizontal sweep, and the horizontal scale is 3 ns/div. In the 10-Eye mode, you can observe events that are correlated with the serial word rate or horizontal line rate. In this mode, you can also observe systematic errors that affect certain bits in the data word.

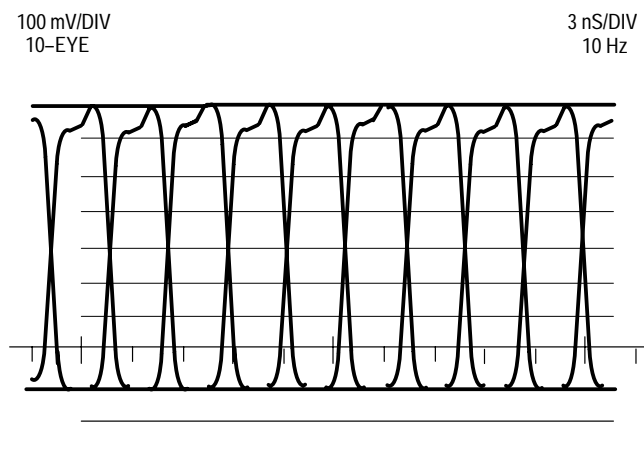

Figure 3–19: 10-EYE triggered display

To select the trigger mode, press the CONFIG button and use the bezel knob to select the EYE PATTERN menu. Press the DISPLAY bezel button to select OVERLAY or 10 EYE. The trigger mode is indicated by a readout in the upper left corner of the CRT. The trigger modes are available with both EYE and EYE EQ displays.

Gain The calibrated vertical gain for the EYE and EQ EYE modes is 100 mV/div. You can expand the vertical scale by selecting X5, X10, or Variable gain. The vertical scale is displayed in the upper left corner of the CRT screen. Press the GAIN button to access the X5, X10, and Variable Gain gain selections. When Variable Gain is enabled, a “>” appears in front of the deflection factor to indicate the uncalibrated condition.

Eye Pattern Measurements

This section describes how to measure parameters of the Eye pattern to verify standard signal specifications for serial digital transmission. The measurements discussed here are amplitude, aberrations, rise time, and jitter. Figure 3–20 illustrates the initial equipment connections.

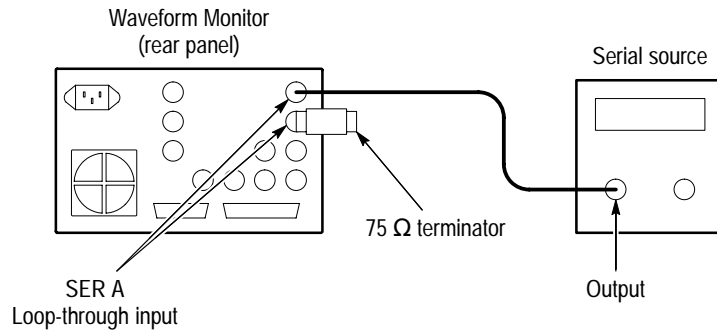

Figure 3–20: Connections for measuring a serial source

Setup for Measurements. Perform the following steps in preparation for the Eye pattern measurements. Figure 3–20 illustrates the equipment connections.

1. Connect the serial source to the monitor with a 75 Ω cable two meters or less in length. Use high quality, low loss coaxial cable, such as Belden 8281.
2. Connect a 75 Ω terminator with at least 25 dB return loss to 300 MHz on the other end of the loop-through input.
3. Set the serial source to output a 100% Color Bar signal.
4. Press the EYE/JITTER button to select the Eye Pattern display.
5. Press the GAIN MENU button and select 1X vertical gain.
6. Adjust the vertical position so the bottom of the waveform rests on the -1 V line.

Measuring Amplitude. Measuring the signal amplitude can help you determine if the signal amplitude is too low due to cable losses or other system problems. This procedure shows you how to measure the signal amplitude using both the graticule and the Voltage Cursors. To measure the signal amplitude, follow these steps:

1. Perform the initial settings for Eye measurements described on page 3–22.
2. Select the desired input channel (SER A or B).

3. Use either the OVERLAY or 10-EYE display mode. Press the CONFIG MENU button and select the EYE PATTERN menu to choose OVERLAY or 10-EYE.
4. Set CLOCK BW, in the Config EYE menu, to 1kHz in order to reduce the effects of time jitter, which can obscure the amplitude measurement.
5. For graticule measurement, select X1 vertical gain and make sure that variable gain is off. At X1 gain, the scale is 100 mV/div.
6. Use the VERT POS knob to position the waveform bottom at the 0 V line. If the waveform exceeds 800 mV, position its bottom at the -0.1 , -0.2 , or -0.3 V line. Measure the amplitude at a horizontal part of the waveform top line.
7. Enable the Voltage Cursors.
8. Position one cursor at the top horizontal part of the waveform; ignore any overshoot on the rising edge.
9. Position the second cursor at the bottom of the waveform; ignore any undershoot. The Voltage Cursor readout gives the signal amplitude.
10. For Cursor measurements, you can use any gain setting, including variable gain, since the waveform and the cursors are equally affected by the gain setting. Use higher gain settings, such as X5, to help match the cursor to the waveform.

Signal sources should measure $800 \text{ mV}_{\text{p-p}} \pm 10\%$. Signal amplitudes outside this range can degrade receiver performance.

Measuring Aberrations. Serial sources should produce good signal transitions with a minimum of overshoot and ringing. Automatic equalizer circuits in receivers may be sensitive to aberrations greater than 10%.

To measure aberrations, perform the following steps:

1. Perform the initial settings for Eye measurements described on page 3–22.
2. Enable the Voltage Cursors.
3. Place one cursor at the peak of the overshoot and the other at the bottom of the topline of the waveform. Include any ringing (the oscillation following overshoot) in the measurement. Essentially, you are measuring the thickness of the top line of the waveform.
4. Perform the same cursor measurement on the bottom line thickness, including any undershoot and ringing.
5. Aberrations at the top or bottom line should not exceed 10% of the signal amplitude.

The Eye display bandwidth of the waveform monitor is 450 MHz, so it can not display aberrations faster than this. Most receiver circuits are also bandwidth limited and usually ignore fast transients. This common bandwidth makes the waveform monitor a good indicator of problem sources in systems.

Measuring Rise Time. Rise time measurements provide a check on the performance of sources and signal degradation by cabling.

To measure rise time, perform the following steps:

1. Perform the initial settings for Eye measurements described on page 3–22.
2. Select Variable Gain and size the waveform to 10 major divisions.
3. Use the Vert Pos bezel knob to position the bottom of the trace at the $-.3$ line and check that the top is aligned with the $.7$ V line.
4. Enable the Timing Cursors.
5. Align the cursors as shown in Figure 3–21. The first cursor is at the crossing of the rising edge and $-.1$ V line. The second cursor is at the crossing of the rising edge and the $.5$ V line. Use the horizontal MAG for greater accuracy when adjusting the cursors.
6. The indicated Δt time value is the standard 20 – 80% rise time measurement.

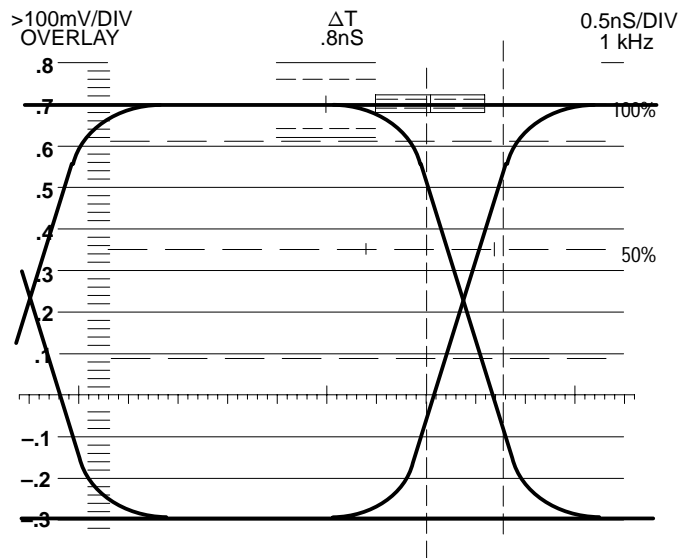

Figure 3–21: Timing Cursors alignment for measuring 20–80% rise time

Calculating Actual Rise Time. The waveform monitor Eye display has a bandwidth of 450 MHz which equates to a 20 – 80% rise time of 500 ps. Consider this finite rise time when you measure the displayed rise time. You can calculate the actual rise time of the source being measured using the following formula:

$$T_{R(\text{source})} = \sqrt{(T_{R(\text{measured})})^2 - (0.5\text{ns})^2}$$

$T_{R(\text{source})}$ = the actual 20 – 80% rise time of the source (in ns);

$T_{R(\text{measured})}$ = the 20 – 80% rise time measured on the waveform monitor (in ns)

Table 3–1 lists actual rise times for a number of rise time values measured with the waveform monitor.

Table 3–1: List of measured and actual rise times for the waveform monitor

20–80% rise time measured	Actual 20–80% rise time
640 ps	400 ps
710 ps	500 ps
780 ps	600 ps
860 ps	700 ps
900 ps	750 ps
940 ps	800 ps
1.0 ns	900 ps
1.1 ns	1.0 ns
1.2 ns	1.1 ns
1.3 ns	1.2 ns
1.4 ns	1.3 ns
1.5 ns	1.4 ns
1.6 ns	1.5 ns

Measuring Jitter. The Eye display in Overlaid mode provides a quick way to measure timing jitter. The WFM 601M waveform monitor also provides an automated Jitter measurement described on page 3–37.

Timing jitter is the deviation of signal transitions compared to those of a reference clock. Ideally, all data bit transitions occur at equal intervals. In real systems, factors such as noise, pulse distortion, and variations in bit patterns cause timing jitter. Jitter results in Eye closure along the time axis, narrowing the window in which the data values can be accurately determined. Data errors result when the Eye becomes too narrow.

Jitter is characterized by both its magnitude and frequency. Signal transitions deviate from their ideal position by a peak amount and at one or more frequencies, depending on the sources. The frequency of the jitter is important in determining its effect on the system. Typically, only high frequency jitter affects data recovery. But low frequency jitter can affect time-critical operations such as signal multiplexing and D/A conversion.

The waveform monitor provides three bandwidth filters: 10 Hz, 100 Hz, and 1 kHz. These filters only show jitter terms above the selected filter frequency. For example, with 1 kHz selected, 50 Hz jitter is heavily attenuated while 10 kHz jitter appears unattenuated.

To measure timing jitter with the waveform monitor, perform the following steps:

1. Perform the initial settings for Eye measurements described on page 3–22.
2. Choose the OVERLAY display mode (located in the EYE PATTERN CONFIGure menu). In this mode, each of the ten bits of a scrambled serial word are overlaid in the same location, showing peak jitter at each eye crossing.
3. Select the appropriate BW Limit filter. Take two measurements: one with the 10 Hz filter, showing total broadband jitter, and one with the 1 kHz filter, which removes the low-frequency jitter.
4. Enable the Timing Cursors.
5. Position the cursors to measure the Eye zero-crossing point.
6. Set Gain to X5 for better vertical resolution; use SWEEP MAG for better horizontal resolution.

Suggested limits for jitter are 740 ps p-p over one horizontal line, measured with the 1 kHz BW Limit filter. If composite D/A conversion is planned, use the 10 Hz BW Limit filter and the same 740 ps p-p limit.

To date, many of the jitter problems in systems have been the result of genlocking clocks to other references such as the horizontal synchronization pulse. Reference jitter transferred by genlocks into a serial system is typically between 20 and several hundred hertz. Also, the phase detection process used by the

genlock can add noise, which results in jitter in the 10 Hz to 1 kHz range. By using the appropriate BW Limit filter, genlock jitter can be included or rejected from a jitter measurement.

Observing Word Correlated Behavior. The Eye Pattern display in 10-Eye mode allows you to analyze word correlated jitter. When video is serialized, a 270 MHz serial clock is derived from the 27 MHz rate parallel word clock. Often there is slight phase modulation of the serial clock between the transitions of the parallel clock producing jitter at data-bit transitions. This jitter is not random; it is correlated to the parallel word rate. Also, the video pattern applied to the serializer changes at a 27 MHz rate or at an integer fraction of this rate. Any video pattern related effects in the serial system typically appear at fixed data-bit locations with respect to the parallel word.

In the Eye display 10-EYE mode, the trigger is on the parallel word boundaries, with 10 Eyes shown per sweep. Parallel word and tv-line correlated behavior can be seen in this mode. If a serial system has a disturbance that appears related to video patterns, either word or tv-line, use the 10-EYE mode in either EYE or EQ EYE to analyze the problem. Use the Line Select function to place the area of interest in the Eye pattern display.

Filter Menu

The Filter menu provides selection of input signal filters for the Waveform and Parade display modes. The three available filters are FLAT (unfiltered), LPASS (1 MHz low pass filter), and the DIFF (differentiated steps filter).

Pressing CLEAR MENU turns off the filter selection readout. To turn off the Filter selection and leave the Filter menu, press the FILTER button (press the button twice if the Filter menu is not displayed). Leaving the FILTER menu returns the monitor to the unfiltered (FLAT) setting.

Gain Menu

The GAIN menu allows you to expand the display vertically by set levels or to vary it continuously. The expanded waveform lets you inspect a waveform feature or more precisely position a cursor for a measurement.

Press the GAIN MENU button to access the Gain menu. Use the fixed bezel buttons to select from the gain settings of X1, X5, X10, and Variable gain. Gain is useful in all display modes except PICTURE mode. In Vector displays, variable gain changes both horizontal and vertical gain equally. Lightning and Diamond displays have both horizontal and vertical variable gain.

CLEAR MENU turns off all of the menu readout, except the VAR GAIN label. Variable gain remains active as long as the front-panel GAIN indicator is lit.

To turn Gain off, press the GAIN button once (twice if the Gain menu is not visible). When you quit the Gain menu, Variable gain returns to the calibrated setting and Vertical gain returns to X1.

Gamut Displays

The waveform monitor features two types of gamut displays. The Diamond display checks video signals for proper RGB gamut. The Arrowhead display checks composite-coded video signals. Both gamut, or signal limit, displays can trigger an alarm when the input signal exceeds a gamut limit.

Press the VECTOR/GAMUT button to select GAMUT. Use the bottom bezel button to select either the Diamond or Arrowhead display mode. This selection may not be visible when other MENU functions, such as GAIN, are active. Press the CLEAR SCREEN button to remove other function menus.

Diamond Display

The Diamond display is very effective at showing the relationship between the R, G, and B signal video signals. The waveform monitor converts the Y, P_b, and P_r components recovered from the serial signal to R, G, and B to form the Diamond display. Figure 3–22 shows how the Diamond plot is developed.

Ultimately all color video signals are coded as RGB for display on a picture monitor. To predictably display all three components, they must lie between peak white, 700 mV, and black, 0 V. Picture monitors handle excursions outside the standard range (gamut) in different ways.

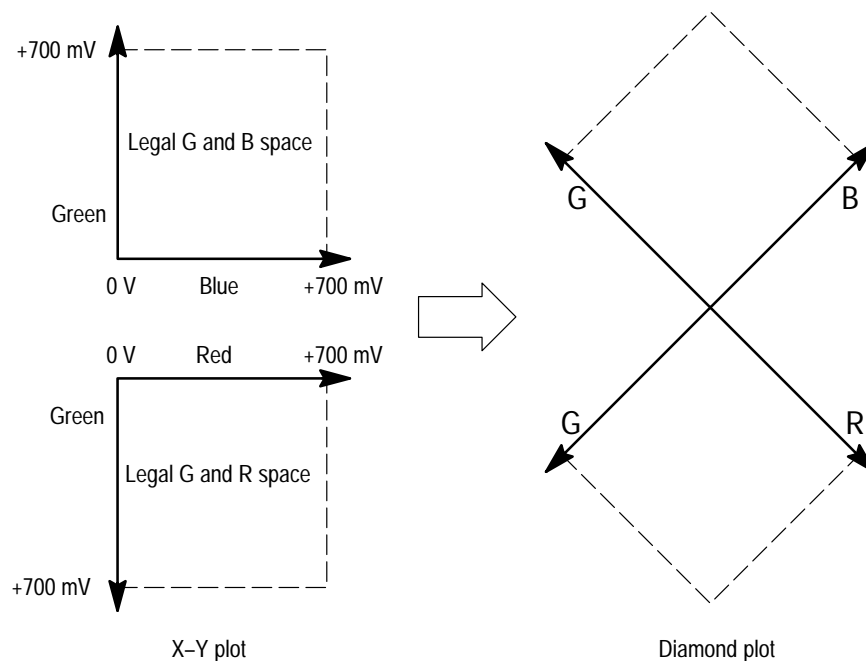

Figure 3–22: Construction of the Diamond display

Checking RGB Gamut. For a signal to be in gamut, all signal vectors must lie within the G-B and G-R diamonds. Conversely, if a vector extends outside the diamond, it is out of gamut. The direction of an excursion out of gamut indicates which signal is excessive. Errors in green amplitude affect both diamonds equally, while blue amplitude errors affect only the top diamond and red errors affect only the bottom diamond. You can set an alarm to indicate when the signal exceeds the RGB gamut. For information on setting the gamut alarm, refer to *Gamut Alarms* on page 3–33.

The intensity of a vector indicates its duration. A momentary out-of-gamut condition appears as a faint trace. Long duration violations show as a bright trace. Figure 3–23 gives some sample out-of-gamut signals on the Diamond display.

On the Diamond Display, monochrome signals appear as vertical lines. Nonlinear component processing, such as from a gamma corrector that alters white balance, can cause deviations along the vertical axis.

As with the lightning display, bending of the transitions indicates timing delays. When a color bar signal is applied, the vertical axis becomes an indicator of delay errors.

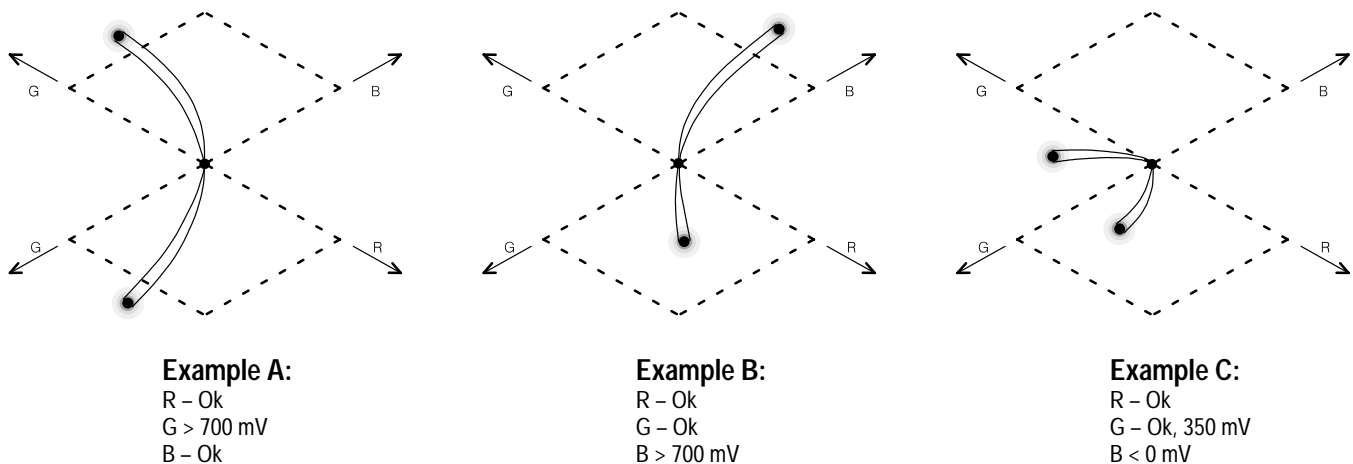

Figure 3–23: Out-of-gamut signals on a Diamond display

Arrowhead Gamut

The Arrowhead gamut display plots luminance (Y) against chrominance (C) to check if the composite signal adheres to standard gamut. Figure 3–24 shows NTSC and PAL Arrowhead displays (75% Color bars) and indicates the values of the graticule lines. The arrow-head shape of the graticule results from overlaying the standard limits for luminance and luminance plus peak chrominance.

NTSC display**PAL display**

Figure 3–24: NTSC and PAL Arrowhead gamut displays

Signals exceeding the luminance amplitude gamut extend above the top horizontal limit (top electronic graticule line). Signals exceeding the luminance plus peak chrominance amplitude gamut extend beyond the upper and lower diagonal limits. The bottom horizontal line shows the minimum allowed luminance level of 7.5 IRE for NTSC and 0 mV for PAL. See Figure 3–24.

Graticule Format. The electronic graticule is different for PAL and NTSC formats. Use the CONFIG GAMUT menu to select the Limit Format. The AUTO selection in the Gamut Configure menu determines the correct graticule from your input signal. A field rate of 60 Hz indicates NTSC and 50 Hz indicates PAL.

NTSC and PAL Limit Cursors. The alarm limit cursor sets the upper amplitude point at which an alarm is triggered. In Figure 3–24, the NTSC limit cursor is set to 120 IRE, as indicated at the upper right of the Arrowhead graticule. Set the NTSC limit cursor to 100, 110, 120, or 131 IRE to fit your operating practices. Likewise set the PAL limit cursor to 700 mV or 950 mV. Use the CONFIG GAMUT menu to set the gamut level.

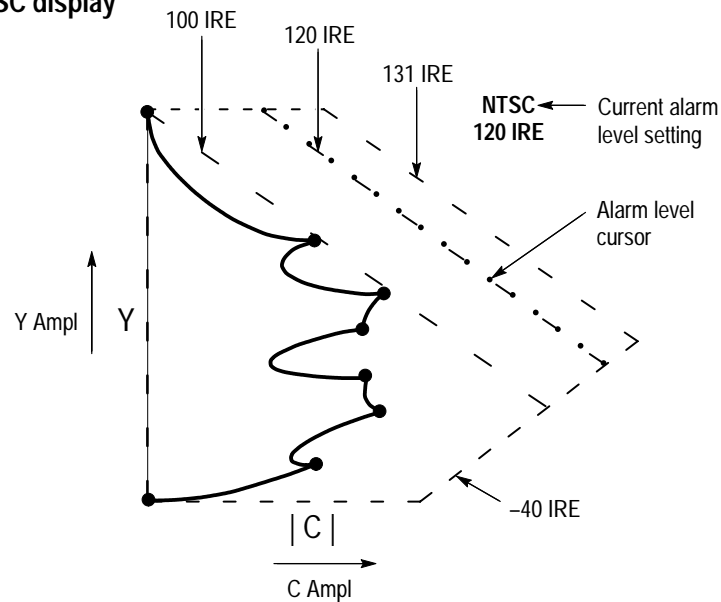
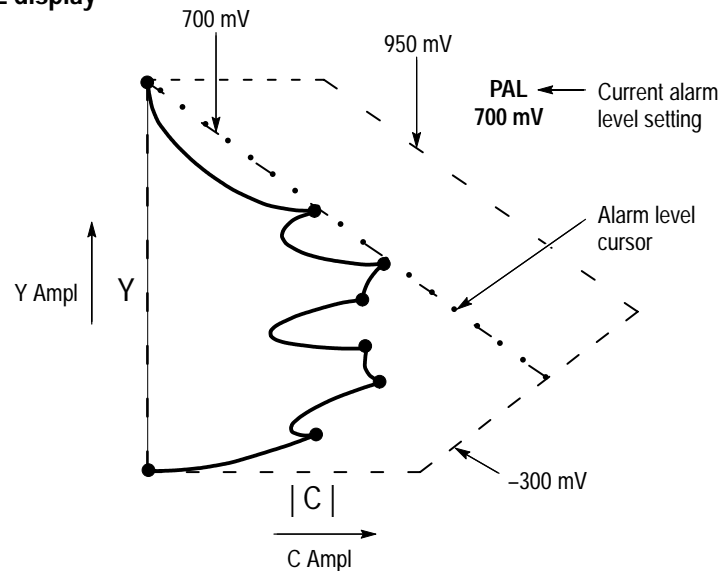
For information on setting the gamut alarm, refer to *Gamut Alarms* on page 3–33.

Checking Composite Gamut. The Arrowhead display provides an automated check on adherence to RGB or composite gamut standards with the Alarm feature discussed on page 3–33. To perform an automated gamut check, enable the alarm and set the level. The automated check alerts you whenever the signal exceeds the set limit.

Another useful Arrowhead function is a measure of how well the active video signal is using the dynamic range of video channel. A properly adjusted signal should be centered in the arrowhead graticule and have transitions that approach all the limits.

Gamut Alarms

The Gamut display modes can alert you whenever a signal exceeds a selected limit. You can set alarm limits for both the Diamond RGB display and Arrowhead composite display. The alarm can take the form of an alarm message in the lower left corner of the CRT or a flashing of the MON OUT signal.

To set either the RGB or composite alarm, follow these steps:

1. Press the CONFIG button and select the GAMUT menu.
2. Select the type of GAMUT CHECK from these choices:
 - CMPST (composite) for the Arrowhead display
 - RGB for the Diamond display. RGB mode checks the R, G, and B signals for transitions below 0 mV and above 700 mV.
 - BOTH enables RGB and CMPST gamut checks.
3. Select the type of ALARM DISP (display) you want from:
 - SCREEN places an error message at the lower left of the CRT.
 - PIX MON flashes the analog output monitor signal in the area that exceeds the limits.
 - BOTH enables both SCREEN and PIX MON alarm displays.
4. Set the adjustable limit cursor to 100, 110, 120, or 131 IRE for NTSC or 700 mV or 950 mV for PAL.

When an alarm condition occurs, a message appears or the monitor flashes for at least one second. In addition, pin 16 of the Remote rear panel connector is pulsed low. Refer to Remote Connector discussion on page B-2 for more information.

Graticule Measurements

The waveform monitor provides an internal etched graticule for waveform measurements. The internal graticule scales are on the same plane as the CRT phosphor to reduce parallax errors. You can adjust the graticule and trace illumination in the CRT menu for viewing or photographing the display. Figure 3–25 shows the etched graticule.

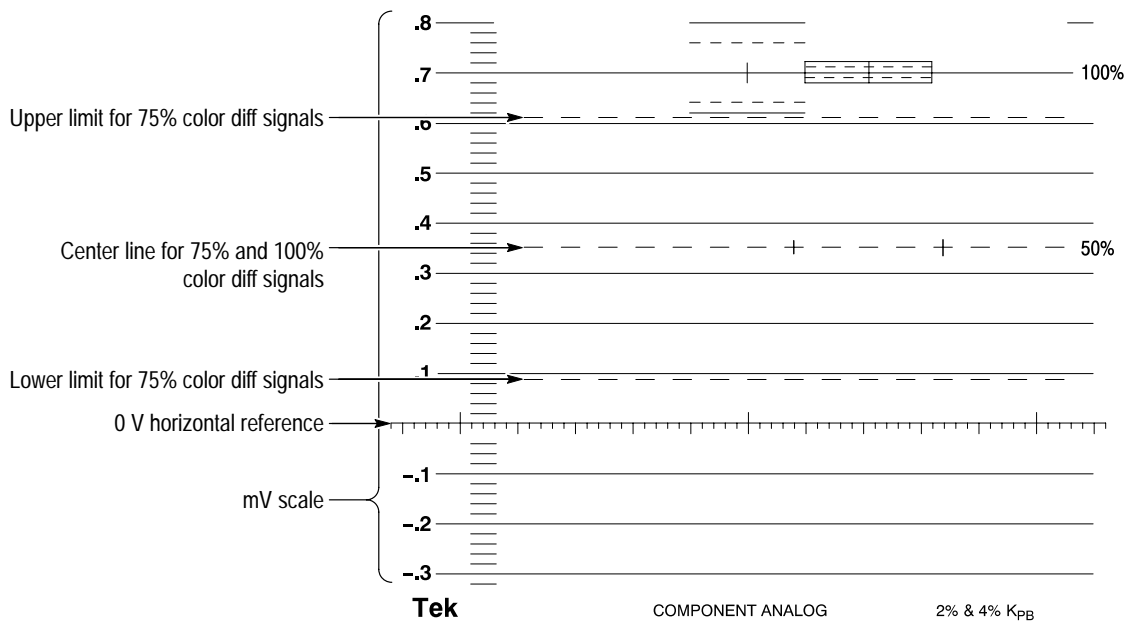

Figure 3–25: Waveform measurement graticule

Vertical Scale

This etched scale facilitates direct Waveform and Parade measurements. The vertical scale is marked in millivolts (mV) and extends from -300 mV to +800 mV in 100 mV increments.

There are three dashed lines on the graticule used to measure the color difference signals, Pb and Pr. The line at 50% amplitude is the center line for the color difference signal measurements. The lines at 90 mV and 610 mV correspond to the peak excursions for 75% color difference signals. 100% color difference signals extend from the baseline (0 V) to 700 mV, centered on the 50% graticule line.

K-Factor Graticule. A special graticule located at the top of the etched graticule allows measurement of K-Factor line-time distortion. Figure 3–26 shows the special graticule and how to align a 2T Bar waveform to measure time-line distortion.

The graticule does not include the first and last 1 μ s of the bar where short-time distortions (ringing, overshoot, undershoot, etc.) occur. The solid outer box equals a 4% K factor, while the dashed-line inner box equals a 2% K factor.

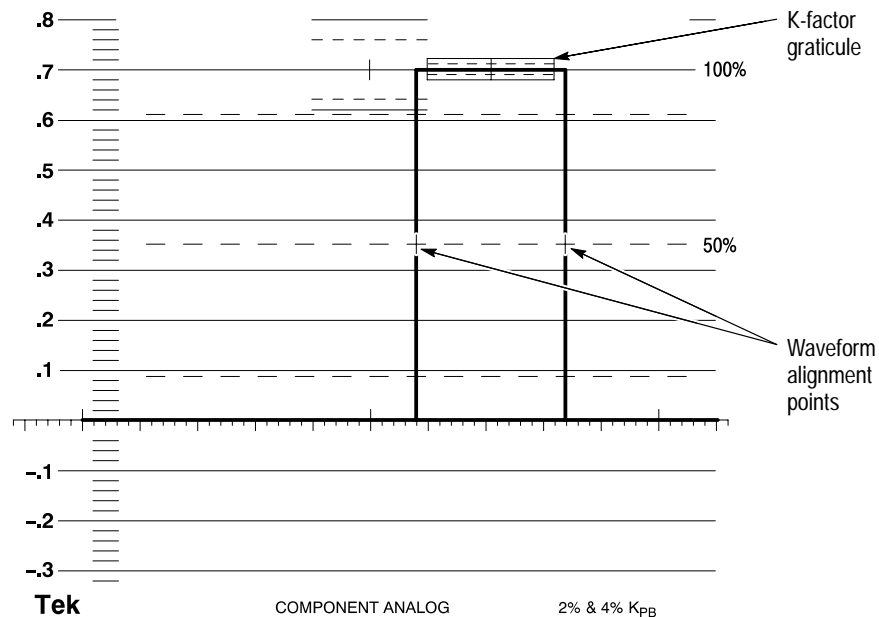

Figure 3–26: Graticule for K-factor measurements

To measure the K-factor distortion follow these steps:

1. Apply a 700 mV 2T bar signal with a 26 μ s duration bar to the active Serial input.
2. Adjust the waveform so its bottom is on the 0 V line and its top is on the 700 mV line. If necessary, adjust the Variable Gain in the GAIN menu so the waveform spans the 0 V to 700 mV lines. Note the rising and falling edges of the waveform must align with the marks on the 50% line.
3. After initial alignment, measure the largest deviation of the bar top (tilt or rounding) using the K-factor graticule. You can expand the waveform by setting Gain to X5. The K factor graticule lines then measure 0.8% and 0.4% K factor.

2T Pulse to Bar. 2T pulse-to-bar measurements are made using the solid and dashed lines located to the left of the K-Factor graticule. Setup is the same as for K-Factor measurement. The 2T pulse-to-bar graticule lines are scaled according to the following formula:

$$\frac{1}{(1-4K)} \text{ and } \frac{1}{(1+4K)}$$

Where:

K = 0.02 for 2% K Factor (using the dashed lines)

or

K = 0.04 for 4% K Factor (using the solid lines)

Set Gain to X5 to increase the resolution to 0.4% and 0.8%.

Horizontal Scale

The horizontal reference line (0 V) is also referred to as the base line, 0 mV, blanking level, and black level. The reference line has 12 major divisions. Main marks at the 1st, 6th, and 11th divisions provide for timing and linearity measurements, which should occur within the center ten divisions. When the Sweep button is set to 1-Line, each major division represents 5 μ s, and when set to 2-Line sweep, each major division represents 10 μ s. The current deflection factor is displayed in the upper-right corner of the CRT.

Pressing the MAG button magnifies the sweep so the scale on the baseline equals 500 ns per major division for 1-Line sweep and 1 μ s per major division in 2-Line sweep. Use the HORIZ POS knob to view the waveform extremes when magnified.

Jitter Measurement Display (WFM 601M Only)

The Jitter display mode provides an automatic peak-to-peak measure of time jitter on the active SER A or B input signal. Selectable high-pass filters allow you to distinguish between high and low frequency jitter. Figure 3–27 shows an example of the Jitter display including a sample jitter waveform. The jitter mode converts any phase modulation to amplitude and plots it against time. An unfiltered version of the jitter waveform appears on the JITTER OUT BNC connector on the rear-panel.

Jitter measurements appear in the Jitter measurement box. The left measurement is Timing or wideband peak-to-peak jitter from 10 Hz to 5 MHz. The right measurement gives filtered peak-to-peak jitter measured after the high-pass filter. The selected high-pass filter is indicated above the filtered jitter measurement.

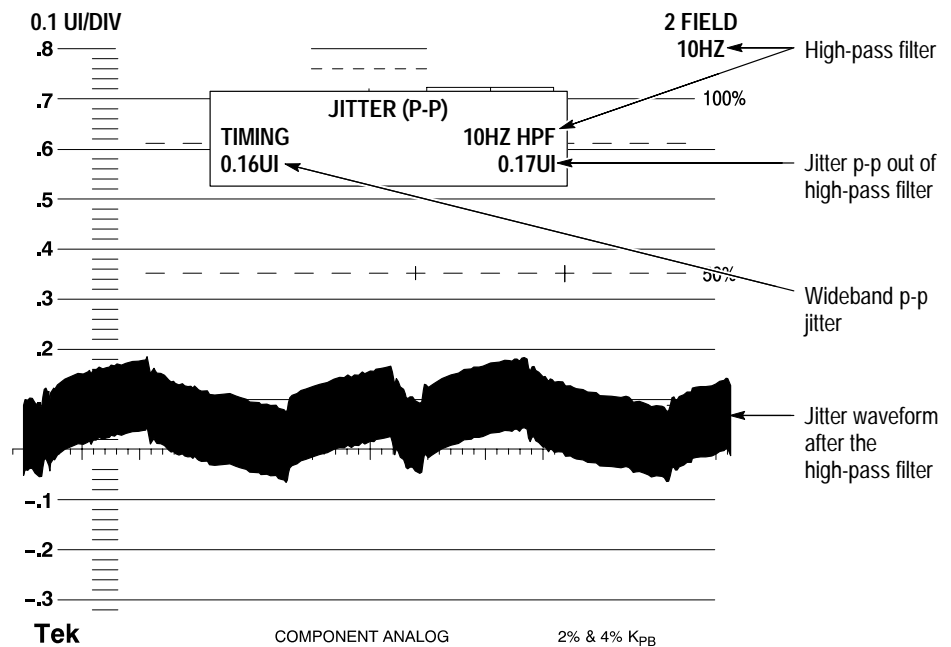

Figure 3–27: Example of the Jitter display

Jitter Demodulation

The Jitter measurement uses a demodulator method to determine signal jitter. The serial clock is recovered from the input signal and multiplied (demodulated) against a very stable oscillator, which translates any phase modulation (jitter) into a DC value. The resulting DC values plotted against time is proportional to jitter in the serial signal. This jitter waveform is passed through a high-pass filter and applied to a peak detector. The peak detector measurement is presented in the jitter measurement box seen in Figure 3–27. The demodulator can detect jitter up to 5 MHz.

Jitter Measurement Configuration

The Jitter measurement lets you pick one of four high-pass filters and set the readout units. Press the CONFIG MENU button and select JITTER. Use the JITTER HPF bezel button to select from the available filters: 10 Hz, 1 kHz, 10 kHz, and 100 kHz. The jitter readout displays in seconds (SEC) or unit intervals (UI). Use the READOUT bezel button select the unit type or turn off the readout.

You can display the jitter waveform using any of the LINE/FIELD sweep selections. You can also use the Line Select function to view an individual line. Vertical Gain and horizontal MAG are available to enhance your view of the jitter waveform. Use the Voltage Cursors to measure specific parts of the jitter waveform. The Jitter Config menu READOUT selection determines the units for the Voltage Cursors.

Line Select

The Line Select menu lets you select the part of the extracted video signal to display and measure. You can select one line, 15 lines, or a single sample on any line in any field. The selected part is indicated on the MON OUT signals as highlighted video.

A readout in the upper left of the CRT indicates the currently selected field, line, and sample. For example, the display F1:22, SMP1441 means that field 1, line 22 and sample 1441 is selected. In 15 H mode, starting and ending line numbers are given. In 525 line standard with field 2 selected, sequential line numbers appear in parenthesis.

To set the Line Select mode, press the LIN SEL MENU button. The Line Select menu appears offering control selections. Bezel knobs are assigned to select line number and sample (in SAMPLE mode).

Field Selection

The bezel buttons FIELD and NEXT FIELD select the field from which the selected line/sample is taken. Selecting ALL displays the same line number from both fields in a frame. The “1 of 2” selection lets you choose a line from only one field in a frame. Press the NEXT FIELD button repeatedly to cycle through the fields in a frame.

Line or Sample Selection

The second bezel button allows selection of 1H, 15H, and SAMPLE (WFM 601M only) display modes. In 1H mode, select a single horizontal line from anywhere in a frame. On the output monitor, the single selected line will be highlighted. When the selected line is near the top or bottom of the frame, the output monitor signal shifts to show the vertical sync region.

In the 15H mode you select a range of lines using the bezel knob. On the output monitor, a band of lines is highlighted. The output monitor signal does not shift as with the 1H and SAMPLE modes.

In the SAMPLE mode, select a horizontal line and a specific sample on that line. In the Waveform and Parade Displays, a rectangular marker or “blivit” shows the selected sample on the waveform. On the output monitor, highlighted horizontal and vertical lines intersect at the selected sample. In the SAMPLE mode, the output monitor display shifts to show the sync region when your selection approaches either end of a line or field. Selections in the sample mode are correlated across most display modes, such as Digital Waveform, Digital Data, Parade, and Waveform display. For example, you can align the blivit to the SAV sample in the Parade mode, then switch to the Digital Waveform mode and see the SAV value in the data stream.

A special condition exists in 15H mode when you select the PARADE or WAVEFORM displays. The first line in the display corresponds with the LIN SEL readout. The second is from the second line and the third is from the third line in the sequence. See Figure 3–28. For more information on how line select affects the Parade mode, refer to page 3–41.

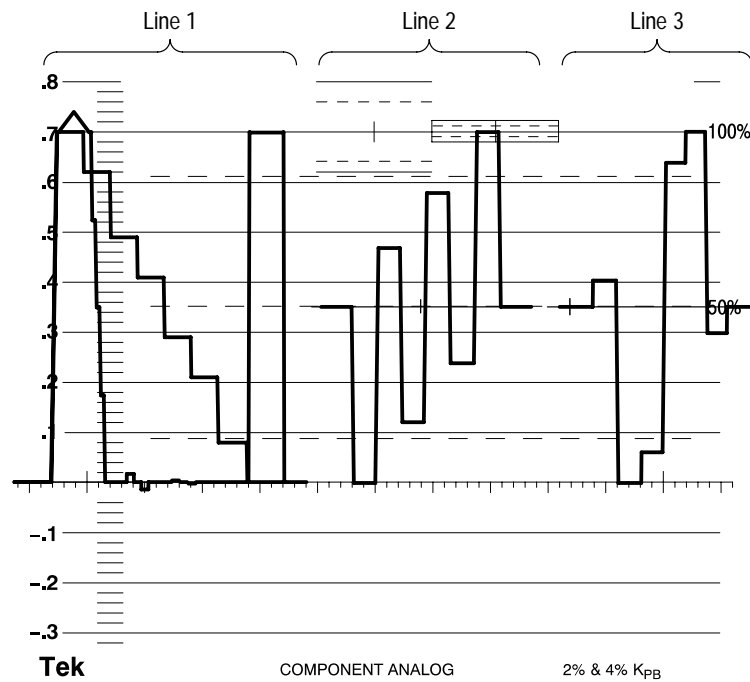

Figure 3–28: Parade display of $Y P_b P_r$ shown in Line Select mode (15H only)

The CLEAR MENU button removes the readout associated with the line selection, but the line number readout and Line Sel control assignment remain active on screen. To restore the menu readout, press the LINE SEL menu button again. To turn off the function press the LINE SEL menu button when the menu readout is displayed; press LIN SEL twice when the menu is not displayed.

Multiple Display

The Multiple display allows you to overlay two display modes. When the Waveform or Parade mode is displayed, you can add either the Vector, Lightning, or Diamond displays. When you exit the Multiple display, the previous display is restored.

Parade Display

Display the component signals Y (CH 1), Pb (CH2), and Pr (CH 3) using the Parade display. You can choose to display one, two, or all three waveforms at once. Measure the waveforms using the graticule or Cursors.

Gain and Sweep selections operate as in the Waveform display. Gain selections are available to expand the waveforms vertically to aid in measurement. The LINE/FIELD button alternates between one line and one field. The MAG selection expands the horizontal scale, while still allowing you to take Cursor timing measurements.

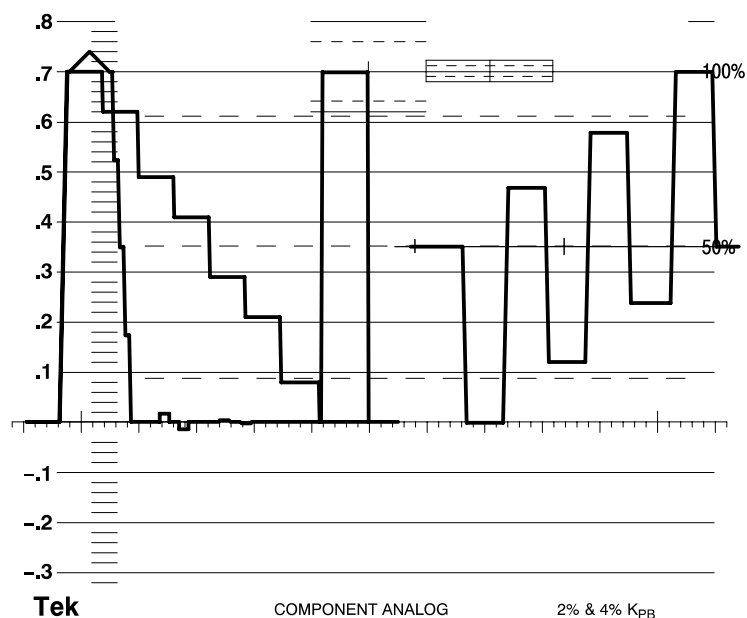

Figure 3-29: Parade display of Y and Pb signals

When Line Select is set to 1H and Ref is internal, the CH 1, CH 2, and CH 3 waveforms are all from the same line. When Line Select is set to 15H or Ref is external, CH 1 is from line n , CH 2 is from line $n+1$, and CH 3 is from line $n+2$.

Picture Display

The Picture display shows a monochrome version of the video signal carried by the serial digital input signal. Figure 3–30 shows an example of a color bar signal. The Picture display lets you verify the signal source. When Line Select is active, the highlight or “bright-up” of the selected line appears as it would on an external analog monitor.

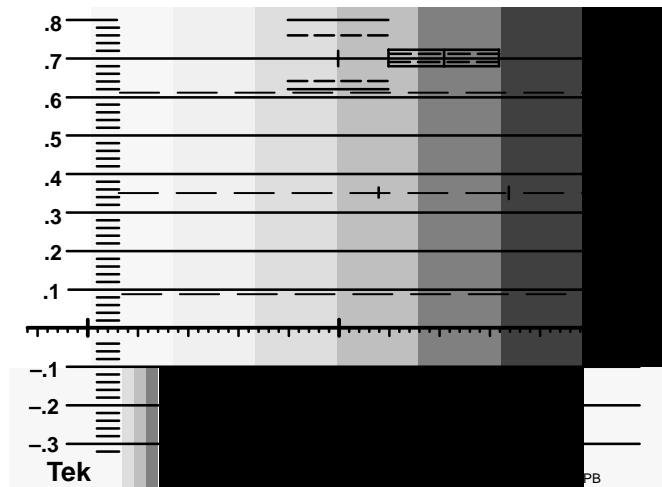

Figure 3–30: Example of the Picture display

To adjust the Picture display, press the CRT MENU button and use the CONTRAST and BLACK LEVEL bezel knobs.

Presets

The Preset menu makes it possible to recall front-panel settings from a list of 10 stored front-panel presets. You can store up to nine front-panel presets at these locations. The remaining one is factory programmed to help calibrate the waveform monitor.

Preset Menu

Press the PRESET MENU button to access the list of the 10 presets. The list appears over a bezel knob below the CRT. Rotating this knob moves the highlight box up or down the list. Once the desired preset is selected, you can take one of four actions:

RECALL. Sets the front panel to the stored settings previously stored into that memory location.

STORE. Wipes out the currently stored settings, in the selected memory location, and replaces them with the current front-panel settings.

RENAME. Allows you to change the name of the current preset selection using a set of alpha-numeric characters and symbols.

RECOVER. Returns to the previously selected choice. For example, assume that Preset 1 was the previous choice and Preset 8 has now been selected but not recalled. Pressing RECOVER returns to Preset 1.

To restore the Preset menu, press the PRESET menu button again. To turn off the Recall function, press CLEAR MENU or the PRESET menu button.

Rename Submenu

Use the Preset Rename submenu to rename one of the nine Presets.

1. Rotate the Location bezel knob to select a character to change in the current name.
2. Rotate the Letter bezel knob to scroll through the list of available characters. The Location character changes as you scroll through the character list. The blank character follows the letter Z.
3. When you are done, press the ACCEPT button to lock the selection.
4. Press the RETURN bezel button to return to the PRESET menu.

Ref Mode

The REF button selects the synchronization reference. The default reference is the currently selected serial digital input (SER A or B). Press the REF button once to select the external reference input (EXT REF). The EXT indicator, located just above the REF button, lights when the external reference is selected. The EXT REF input is a 75 Ω loop-through input. The external reference signal can be a black burst or composite video signal.

Press the REF button again to select the internal synchronization reference and turn off the EXT indicator.

Serial Status

The Serial format display performs automatic checks on the serial digital signal and provides descriptive status of the input signal. Two Serial format screens, STATUS and FORMAT, display information about the serial signal. In addition, the front-panel EDH indicator lights when the input signal contains valid EDH information in accordance with the SMPTE RP-165 standard.

Press the SERIAL button (located below the Alarm indicator) to view the Serial format screens. Figure 3–31 shows the STATUS screen. Press the DISPLAY bezel button to select either the STATUS, FORMAT, or CABLE screen. V1.X firmware instruments do not have the CABLE selection. Press the SERIAL button to exit the Serial format display.

STATUS Screen

The Status screen presents a signal description, the results of EDH checks, and the cable length. Figure 3–31 shows an example of the Status screen displaying a signal with a 525-line rate, 10 bit data, and 16 channels of embedded audio. Figure 3–32 shows the STATUS screen for firmware V1.X instruments.

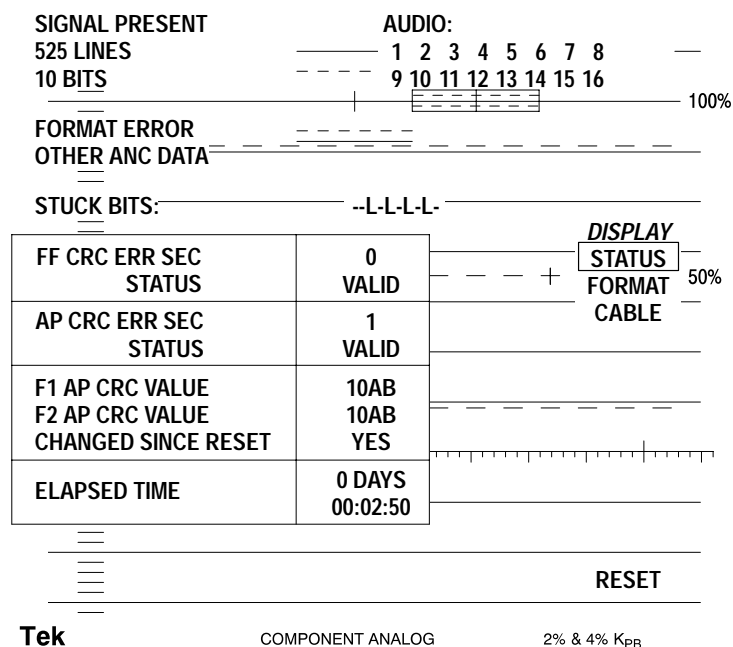

Figure 3–31: Serial STATUS display for firmware V2.X

The status screen provides three types of information. The information at the top describes the type of detected signal including the number of lines, data bits, and audio channels. The Stuck Bits readout shows the status of each bit in the data word with the LSB on the right. Three characters indicate the status of each bit:

- “–” for bits that change during a field
- L indicates bits that stay low
- H for bits that stay high

The table on the Status screen contains EDH (SMPTE RP-165) and CRC error detection results. The elapsed time indicates the sample period for the error detection readout.

Features of the Status Screen. The Status screen features operate as follows:

- **Signal Present.** Indicates when a valid serial digital signal is detected. When the serial receiver detects a no-signal condition, the status will read SIGNAL MISSING.
- **525/625 Lines.** Gives the number of lines in the serial digital signal.
- **10/8 Bits.** Gives the number of data bits in the serial digital signal.
- **Audio.** Gives the number of embedded audio channels detected in the serial digital signal. When the serial digital signal does not contain audio information, the AUDIO readout disappears.
- **Format Error.** (WFM 601E and WFM 601M only) Indicates a format error is present. To see the type of format error, press the DISPLAY bezel button to select FORMAT.
- **Other ANC Data.** (WFM 601E and WFM 601M only) Indicates the presence of ancillary data other than EDH or Audio.
- **Stuck Bits.** (WFM 601E and WFM 601M only) Indicate if any of the 8 or 10 data bits are locked. The LSB is on the right. Active bits are indicated by a hyphen and locked bits by an L for the low state and H for high.
- **FF CRC ERR SEC** (full field CRC errored seconds). Provides an EDH (SMPTE RP-165) measure of asynchronous errored seconds based on CRC calculated for each field in the video signal.
- **AP CRC ERR SEC** (active picture CRC errored seconds). Provides an EDH (SMPTE RP-165) measure of asynchronous errored seconds based on CRC calculated for the active picture part of each video field.
- **F1 AP CRC VALUE** (active picture CRC value). Calculates the AP CRC value for the active video part of field one.
- **F2 AP CRC VALUE** (active picture CRC value). Calculates the AP CRC value for the active video part of field two.
- **Changed Since Reset.** Indicates if either the F1 or F2 AP CRC VALUE has changed since you last reset the timer.
- **Elapsed Time.** Gives the time since you last reset the timer.
- **Reset.** Sets the elapsed time back to zero and clears any detected EDH errors.
- **Display.** (WFM 601E and WFM 601M only) Selects either STATUS, FORMAT, or CABLE screens.

Status Screen for V1.X Firmware

The WFM 601M with V1.X firmware includes cable length and signal strength readouts in the Status screen as shown in Figure 3–32. The other information in the STATUS screen is the same as that shown in Figure 3–31.

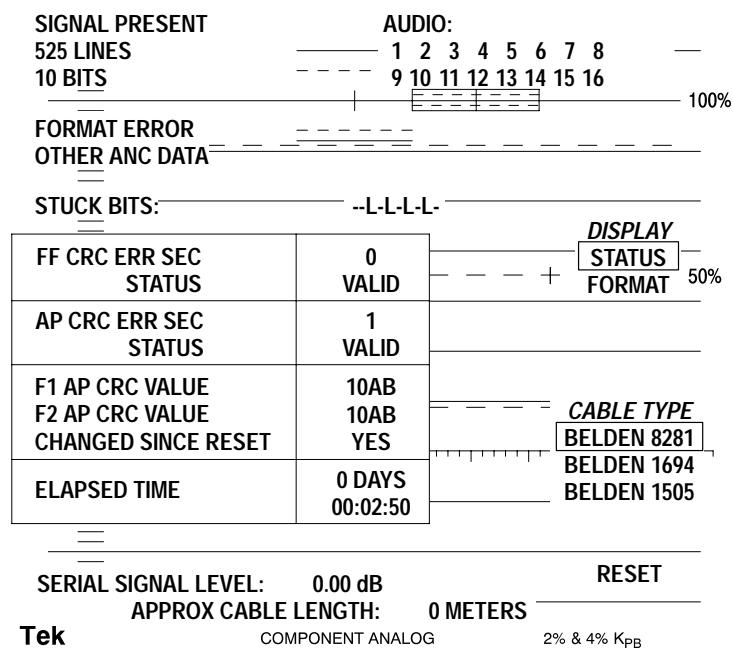

Figure 3–32: Serial STATUS display for firmware V1.X

The V1.X firmware Status screen includes cable measurement features. With V2.X firmware, these features moved to the DISPLAY CABLE screen. The V1.X features provide the following information:

- **CABLE TYPE.** Select the type of cable connecting the video source to the waveform monitor. The correct Cable Type is necessary to calculate the Serial Signal Level and Cable Length.
- **SERIAL SIGNAL LEVEL.** Indicates the amplitude of the signal source relative to the 800 mV standard. The value 0 dB indicates a good 800 mV signal. A value of –3 dB would indicate a source with 0.707 of the expected amplitude. To get an accurate measurement, you must select the correct CABLE TYPE for your installation.
- **APPROXIMATE CABLE LENGTH.** Indicates the length of the cable between the signal source and the waveform monitor. The waveform monitor calculates the cable length based on the signal power at the input. To get an accurate measurement, you must select the correct CABLE TYPE for your installation.

FORMAT Screen (WFM 601E and WFM 601M Only)

The FORMAT screen presents the results of six signal format checks. A given check reports back either OK or ERROR. The waveform monitor continuously performs the format checks. The results are *not* saved or latched; once an error condition clears, the indicator returns to OK. The FORMAT screen is identical for V1.X and V2.X firmware except for the CABLE selection for the DISPLAY bezel button.

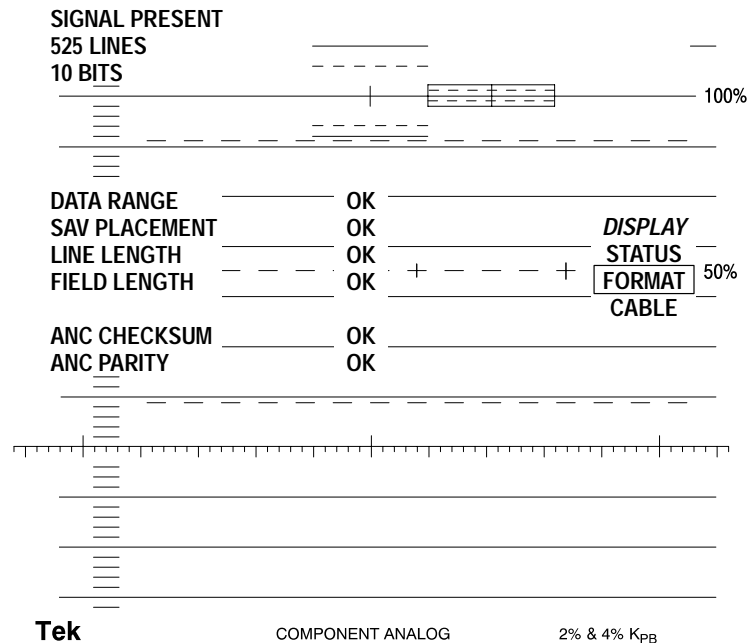

Figure 3-33: Serial format display showing the FORMAT screen

Features of the Format Screen. The Format screen provide the following information:

- Data Range. Indicates an error if the reserved values of 000h–003h or 3FCh–3FFh are used incorrectly.
- Sav Placement. Indicates an error if SAV is improperly placed with respect to the preceding EAV.
- Line Length. Indicates an error if there are an incorrect number of samples from one EAV to the next.
- Field Length. Indicates an error if there are an incorrect number of lines in a field.
- ANC Parity. Indicates an error if a parity error has occurred in ancillary data.

- ANC Checksum. Indicates an error if an ancillary data checksum error has occurred

CABLE Screen (WFM 601E and WFM 601M Only)

The CABLE screen displays signal level and cable length readouts and allows you to select the cable type used in your installation. See Figure 3–34. This screen appears only with firmware V2.X and later.

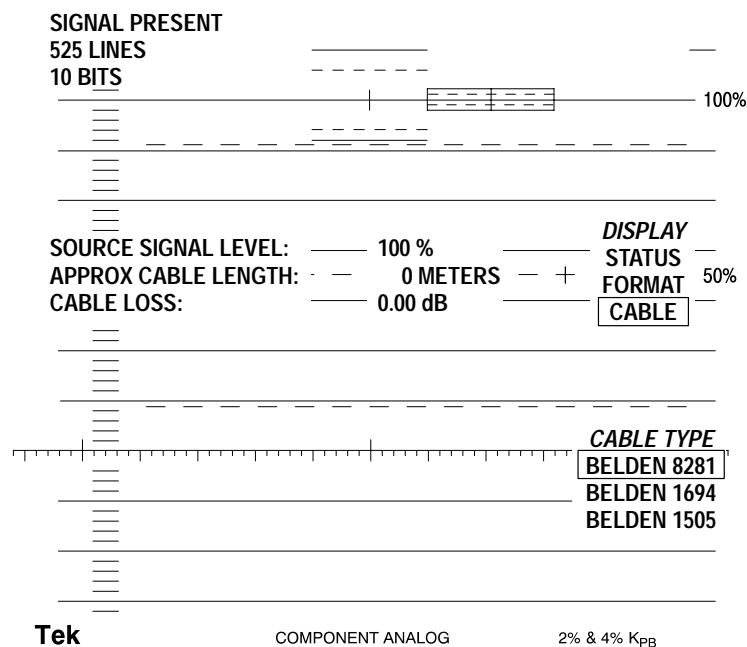

Figure 3–34: Serial format display showing the Cable screen

Features of the Cable Screen. The CABLE screen provides the following information:

- **SOURCE SIGNAL LEVEL.** Indicates the level of the signal source relative to the 800 mV standard. To get an accurate measurement, you must select the correct CABLE TYPE for your installation.
- **APPROX CABLE LENGTH.** Displays the cable length between the signal source and the waveform monitor. The waveform monitor calculates the cable length based on the input signal power and the cable type. To get an accurate measurement, you must select the correct CABLE TYPE for your installation.
- **CABLE LOSS.** Displays the approximate loss of power due to the cable. To get an accurate measurement, you must select the correct CABLE TYPE for your installation.

- **DISPLAY.** Selects either STATUS, FORMAT, or CABLE screens.
- **CABLE TYPE.** Selects the type of cable connecting the signal source to the waveform monitor. The Cable Type sets parameters needed to calculate the Source Signal Level and Approx. Cable Length. Press the CABLE TYPE bezel button to select the correct cable type for your installation.

Measuring Error Rate

The waveform monitor provides two methods for measuring data transmission errors in serial video systems. The first method uses the Error Detection and Handling (EDH) system which documented by the SMPTE RP165 standard. The second uses a fixed pattern test signal and the Active Picture CRC values.

Error Rate Measurement with EDH. The EDH system computes a Cyclic Redundancy Code (CRC) for each field of video and includes it with the video in an ancillary data field. At the EDH receiver, a CRC is calculated for the received field of video and compared against the transmitted CRC. If they do not match, then one or more errors have occurred during that video field.

To measure a serial digital link, the source must insert EDH information. Serial repeaters or processing equipment between the source and the destination receiver must pass ancillary data on the lines where the EDH is inserted. For 525 line standards, EDH data is on lines 9 and 272 and, for 625 line standards, on lines 5 and 318. If your source can not insert EDH, use an alternative source, such as the Tektronix TSG-422 Option 1S Generator. This substitution is effective because sources must generate standard waveforms.

Connect the waveform monitor to the regenerated serial output of the destination receiver as depicted in Figure 3–35.

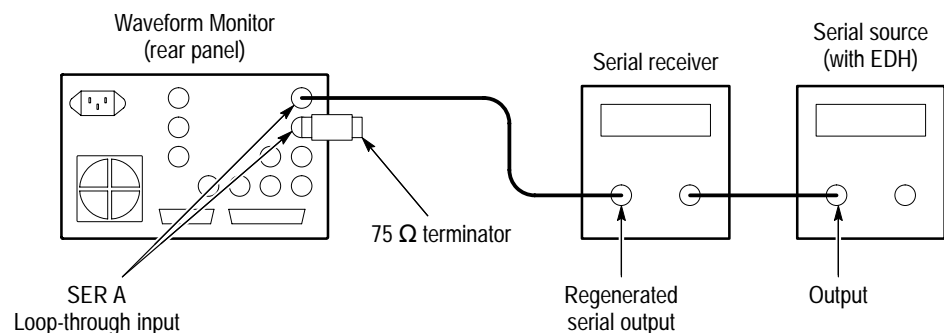

Figure 3–35: Connection for point-to-point error measurements

After making the connections, ensure that the serial source is supplying an EDH compliant signal. Check that the waveform monitor EDH DET indicator is on. Activate the SERIAL STATUS screen. In the error table, the number of program

seconds that contained errors (errored seconds) is indicated. An elapsed time indicator gives the total time since the error counter display was last reset. Use the elapsed time to calculate statistics such as percentage errored seconds. Press the RESET bezel button to set both the errored seconds readouts and the elapsed time counter to zero.

Each ERR SEC readout has a STATUS field just below it. The status can be either Valid, Invalid, or Missing. Valid means a transmitted CRC is available to check for errors. Invalid means some EDH information is present, but the CRC used to check for errors is not available. Missing means that no EDH information is present. In this case, the EDH DET indicator is off. To check the error rate, the EDH CRC being used – either FF (full field) or AP (active picture) – must be Valid. Note that if a CRC becomes Invalid while the error rate is being determined, the ERR SEC readout will freeze. Errors are not detected while the CRC is Invalid.

This measurement method is possible because the serial receiver under test creates the reclocked serial output after it has equalized the input signal, recovered the clock, and latched the data. Any detection errors affecting the receiver also appear in the regenerated serial output and are detected by the waveform monitor.

The ability to measure a receiver error rate by monitoring its regenerated output is very useful in an operating system. Although many types of video equipment do not include EDH error detection, most have regenerated (or reclocked) serial outputs. This technique can bring error rate measurement capability to virtually any point in a facility. Strategic placement of waveform monitors can help track the performance of an operating video system. Similarly, you can use a single EDH monitor to proof an entire digital chain by moving it from one regenerated output to the next.

Error Rate Measurement with AP CRC. The waveform monitor calculates CRC check-words for the active picture area of each video field. The two CRC values are displayed on the SERIAL STATUS screen: one for field 1 (F1) and one for field 2 (F2). With a fixed-pattern test signal, these CRCs should have constant values. Hence, any change in the CRC indicates an error. By passing a static test signal through system equipment, you can look for errors introduced by the system equipment.

Connect the waveform monitor as shown in Figure 3–35. The source does not need EDH, but it must be a *fixed pattern* signal (repeating every two fields). Display the SERIAL STATUS screen. Press the RESET key and check that the CHANGE SINCE RESET flag reads No. If an error occurs, a CRC value will briefly change values then resume the fixed pattern value. Even a very brief change sets the CHANGED SINCE RESET flag to Yes. The elapsed time counter indicates the length of time since the flag was last reset to No. The flag indicates only that one or more errors occurred.

Comparison of the Two Methods. Of the two methods described above, the EDH system is the most powerful. First, it works with any video program material, since the source-end CRC is calculated on a field-by-field basis. It does not matter if the source is a fixed pattern test signal or moving pictures. Thus, EDH can monitor error rate while your facility is in service. Second, the error information gathered by the waveform monitor is the most comprehensive when using EDH, with errored seconds readouts for both the active picture and full field. The big disadvantage of EDH is that it requires calculation and insertion of the CRC at the source. At present, not many equipment vendors support EDH.

The AP CRC Value method does not require any special signal insertion at the source, and therefore gets around the problem of poor support for the EDH system. But its limitation is that it works only with fixed pattern signals, such as those from a test signal generator. This precludes its use for monitoring operating video systems. Also, the AP CRC Value method only indicates if there were zero or more errors.

Sweep

The SWEEP buttons set the sweep rate (time/div) for the horizontal scale and enable horizontal magnification. Press the LINE/FIELD button repeatedly to step through the following sweep modes:

- 1 Line. One horizontal line is displayed. Use Line Select function to choose one line out or a Field or Frame. The horizontal scale is 5 μ s/div.
- 2 Line. Two consecutive horizontal lines are displayed. The horizontal scale is 10 μ s/div.
- 1 Field. All lines for one video field are displayed. No horizontal scaling is given.
- 2 Field. All lines for two video fields are displayed. No horizontal scaling is given.

Use the LIN SEL MENU to choose the line or lines to display.

The MAG button provides a magnified view of the horizontal scale. In the magnified mode, the waveform extends off both sides of the CRT. Use the HORIZ POS bezel knob to pan left and right on the waveform. Timing Cursors operate correctly in the magnified mode, though one or both may be off screen during measurement.

Vector Display Modes

The waveform monitor provides two types of vector displays. One is a conventional Vector display that plots the two color difference signals, Pb and Pr, against each other. The Vector display is useful for checking the chrominance phase and amplitude. The second vector display is the Lightning display. The Lightning display plots luminance (Y) versus Pb on the top and Y versus Pr on the bottom. This display is useful for evaluating component signal amplitude and timing.

Press the VECTOR/GAMUT button to select a Vector display. Press the lower bezel button to select VECTOR or LIGHTNING modes.

Both vector modes can operate with 75% or 100% Color Bar signals. Press the CONFIG MENU button and select the WFM/VEC menu to select the 75% or 100% graticule to match your test signal.

Vector Display

The Vector display plots the two color difference signals, Pb and Pr, against each other, similar to a composite vectorscope. Figure 3–36 shows how the color difference signals are plotted to create the Vector display. Figure 3–37 shows the actual polar graticule with trace lines indicating how a trace would appear on the graticule.

The polar display permits measurements of hue in terms of the relative phase of the chrominance signal. Amplitude of chrominance is the displacement from center (radial dimension of amplitude) towards the color point.

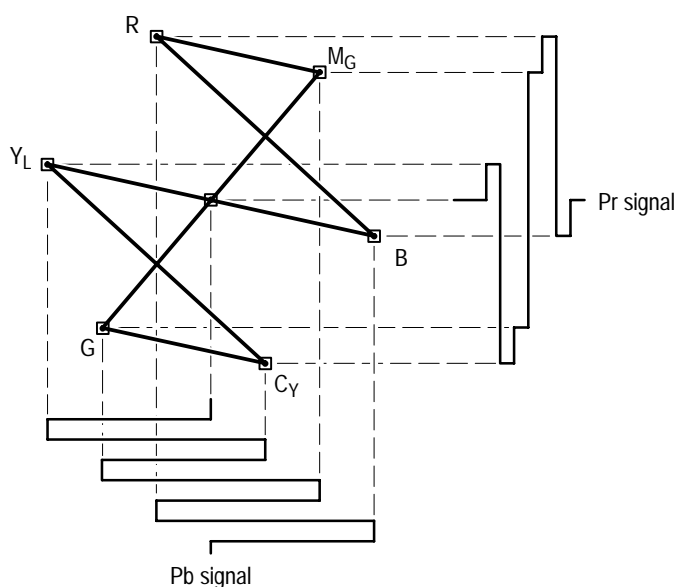

Figure 3–36: Vector display relationship of the Pr and Pb signals

Vector Graticule. The waveform monitor Vector graticule, shown in Figure 3–37, operates as a component vectorscope. Each chrominance vector of a Color Bar signal terminates as a bright dot in a target. The distance from the center box to the target box corresponds to the amplitude for the color being measured. The dot brightness corresponds to the duration of the color bar. The dimension of each target box represents 2% (± 14 mV) of a 700 mV amplitude. The dashed-vector line labeled **I** indicates the saturation or amplitude of flesh tones. The displayed amplitude allows comparison to the Color Bar targets.

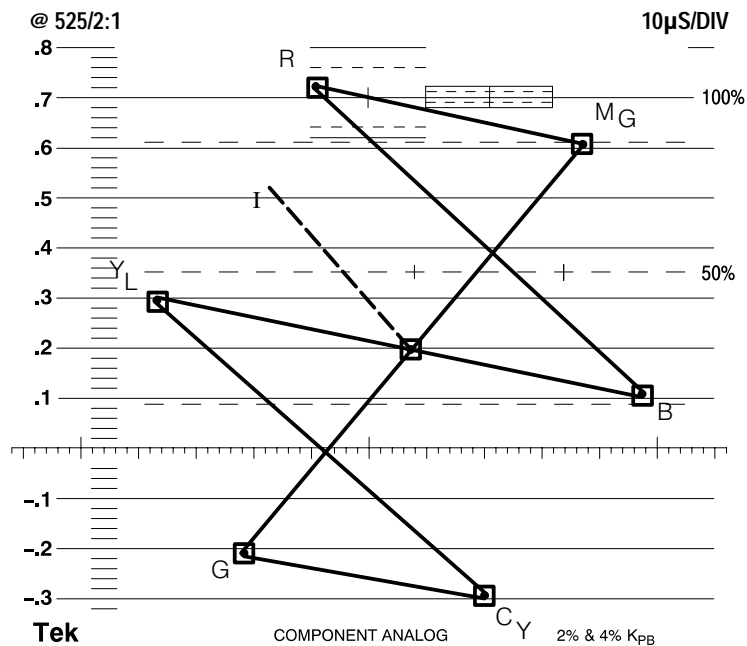

Figure 3–37: Vector display graticule

Phase and Amplitude Measurements. With the Vector display, you can check the encoder accuracy for both phase and amplitude errors. When taking measurements make certain your source signal amplitude matches the Vector graticule. For example, if the source is a 75% Color Bar signal, then choose the 75% graticule in the WFM/VEC Configuration menu. The current graticule selection appears beside the graticule.

Composite signals include a sample of the subcarrier (burst) with each line of video to synchronize the decoding of color information. The Vector display is based on the accuracy of the color burst sample. Any magnitude or phase variance in the color bar vectors is measured by the distance of the vector dots from the appropriate targets.

Vector Timing Measurements. In the composite domain, the transitions between the vector end points display timing differences. But, because these timing differences include the delay in the decoder output filtering, you can usually ignore them. In the component domain there is no decoding required and therefore the color bar transitions contain useful timing information. These timing differences appear as looping or bowing of the transitions. It is possible to measure the amount of bowing and convert the results to a coarse delay value. If the transition looping appears large, use the Lightning display to measure the interchannel delay.

Lightning Display

The Lightning display plots the color difference signals, P_b and P_r , against the luminance (Y) signal. In the top half of the Lightning display, P_b is plotted against Y , and on the bottom half, P_r is plotted against inverted Y . The vertical center is the 0 V or black-clamp point. Figure 3-38 shows how the waveform monitor plots the Lightning display from the three component signals.

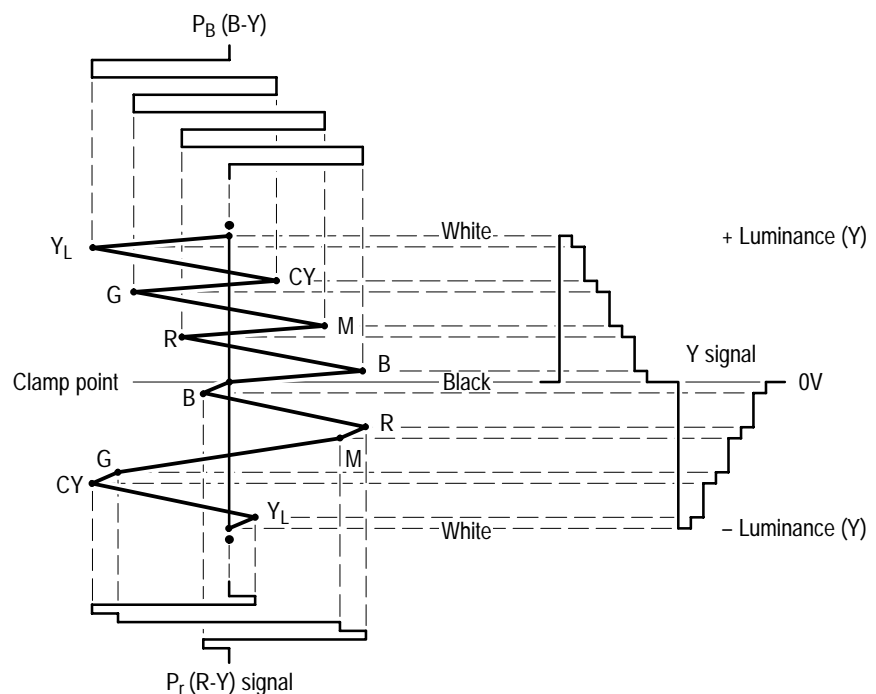

Figure 3-38: Construction of the Lightning display

Figure 3–39 shows the Lightning graticule with a trace. The target boxes at the end of each vector indicate a tolerance of ± 14 mV. The closely spaced small dots provide a guide for checking transitions. These dots are spaced 40 ns apart while the widely spaced dots represent 80 ns. The electronic graticule eliminates the effects of CRT nonlinearity.

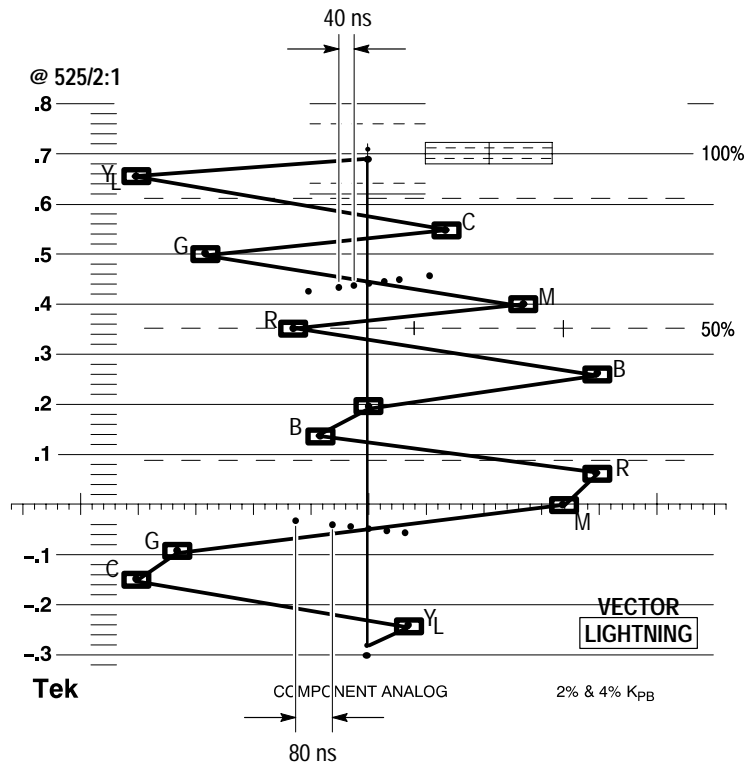

Figure 3–39: Lightning graticule showing interchannel timing errors

The three signals are back-porch clamped and identically low-pass filtered to provide a common point and identical delay through the system. The color difference signals are line alternated, and the luminance signal is inverted on alternate lines.

The information available from the Lightning display is color difference signal accuracy (horizontal displacement of either half of the display), luminance gain (vertical displacement between the black and white levels), timing delay between either color difference signal and luminance (bending of the green/magenta transitions). Figure 3–39 shows the graticule and the measurement targets and timing delay scales.

Luminance Gain Measurement. The signal is driven along the vertical axis above and below the center box by the luminance signal. The lower half is driven down from the center. The luminance gain is correct when the center dot (clamped black level) is centered in the target box and the positive and negative excursions end at the top and bottom of the graticule. Perfect monochrome signals appear as a thin vertical line. Any deviation or bending off the center line indicates a color variation from the monochrome setup of the display monitor. Luminance gain alone can be measured more accurately in either the Waveform or Parade display modes.

Interchannel Timing Measurement. The scale (sequence of dots) between the green and magenta targets provides a way to check interchannel timing (CH-2 to CH-1 and CH-3 to CH-1) or signal delay. If the color difference signal is not coincident with luminance, the transitions between color dots will bend. The amount of this bending represents the relative signal delay between luminance and the color difference signal. The upper half of the display measures the P_b -to-Y timing, while the bottom half measures the P_r -to-Y Timing. If the transition bends in toward the vertical center or black region, the color difference signal is delayed with respect to luminance. If the transition bends out toward white, the color difference signal is leading the luminance signal.

P_r and P_b Gain Measurement. The horizontal deflection of the top half of the display is an indication of the P_b gain and the lower half indicates the P_r gain. If the color bar signal dots are within the horizontal dimensions of the appropriate graticule targets, the P_b and P_r gains are within 2% of the correct amplitude.

Since the vertical and horizontal dimensions of the graticule target boxes indicate 2% luminance and color difference gain errors, respectively, you can evaluate each color bar for encoding accuracy with these limits. The Lightning display shows the relative level or coding accuracy for Y, P_b , and P_r for each of the eight primary colors much better than the Parade display mode.

Video In

The VIDEO IN selections enable Serial input A or B and determine which component signals are displayed. The SERIAL A and B button corresponds to the SER A and B loop-through inputs on the rear panel. Only one input can be active at a time.

The CH 1 button displays the Y or luminance signal. The CH 2 button displays the Pb or B-Y chrominance signal. The CH 3 button displays the Pr or R-Y chrominance signal. In the WFM AS RGB mode, CH 1 displays R, CH 2 displays G, and CH 3 displays B.

Waveform Display

The Waveform display mode displays voltage versus time for the selected video input (A or B). You can display the three input video channels singly or in combination. When you display more than one channel of the input signal, the channel traces are overlaid.

The waveform monitor uses a line-store memory in 1H and Sample Line Select modes which allow it to display all video channels from the same video line. This feature lets you view and measure concurrent data for all three channels.

Line Select

The Line Select menu offers two or three modes depending on your model:

- 1H. Shows one line of a field or frame. A horizontal line on the output monitor signal marks the selected line.
- 15H. Displays 15 successive lines.
- Sample (WFM 601M only). Picks a particular sample in a horizontal line and indicates it with a visible marker on the line.

Cursors

Cursors are available to measure time and amplitude differences.

Gain

Horizontal and vertical magnification are available by pressing the MAG and GAIN buttons. Magnification is also valid during cursor measurements.



Appendices

Appendix A: Specifications

Table A-1 lists the Electrical specifications for the WFM 601A, WFM 601E, and WFM 601M Serial Digital Component Waveform Monitors. Performance Requirements are generally quantitative and can be tested by the Performance Verification Procedure in the Service Manual. Reference information describes useful operating parameters that have typical values. These parameters are not directly checked in the Performance Verification Procedure. Table A-8 lists the EMC compliance specifications.

The Performance Requirements listed in the electrical specification portion of these specifications apply over an ambient temperature range of 0° C to +40° C. The rated accuracies are valid when the instrument is calibrated at an ambient temperature range of +20° C to +30° C, after a warm-up time of 20 minutes.

Table A-1: Electrical specifications

Characteristic	Performance requirement	Reference information
Waveform Vertical Deflection		
Deflection Factor	For digital input: 700 mV digital input = 700 mV ± 2% screen display, any magnifier setting.	RGB on-screen accuracy ± 3%.
Variable Gain Range		0.2X to 1.4X.
Frequency Response	Luminance channel (Y), to 5.0 MHz ± 2%; Color difference channels (P _B and P _R) to 2.5 MHz ± 2%	Typically ± 1% to 5.75 MHz luminance (Y) channel, and ± 1% to 2.75 MHz for the color difference (P _B and P _R) channels.
Transient Response		Preshoot ≤ 1%. Overshoot ≤ 1%. Ringing ≤ 1%. Pulse-to-bar ratio 0.99:1 to 1.01:1
Field Rate Tilt		≤ 1%.
Line Rate Tilt		≤ 1%.
Offscreen Recovery		1% variation in baseline of a 5 MHz modulated pulse when positioned anywhere on screen. X1, X5, or X10 with any variable gain setting.
Voltage Cursor Accuracy	± 0.5% over 20–30° C, ± 1% over rated temperature range.	
Differentiated Step Filter		Amplitude of pulses ≤ 1% variation.
Low Pass Filter		
Gain	1 ± 1%.	
Response		≤ 3 dB attenuation at 1 MHz, ≥ 40 dB attenuation at 4 MHz.

Table A-1: Electrical specifications (cont.)

Characteristic	Performance requirement	Reference information
Serial Digital Video Interface (SER A and SER B inputs)		
Format		270 Mbit/s component. Complies with SMPTE 259M and CCIR 656.
Input Type		Passive loop-through, 75 Ω compensated.
Input Level		800 mV peak-to-peak \pm 10%. Input voltages outside this range might cause reduced receiver performance.
Return Loss		
Power on		\geq 25 dB 1-270 MHz, channels on or off.
Power off		\geq 15 dB 1-270 MHz.
Insertion Loss		\leq 1%.
Transmission Bandwidth		50 kHz – 300 MHz \pm 1.0 dB. -3 dB at not less than 500 MHz.
Loop-through Input Isolation		\geq 50 dB to 300 MHz.
Serial Receiver Equalization Range	Proper operation with 19 dB loss at 135 MHz using coaxial cable having $1/\sqrt{F}$ loss characteristics. 800 mV launch amplitude and 200 meters (655 feet) of Belden 8281 coaxial cable.	
Serial Video Output (follows SER A/B channel selection)		
Format		270 Mbit/s component; complies with SMPTE 259M and CCIR 656.
Output Level	800 mV p-p \pm 10% into 75 Ω load	Internal adjustment can change output to less than 600 mV and greater than 1000 mV.
Return Loss		\geq 15 dB 1-270 MHz
Eye Pattern Display (WFM 601E and WFM 601M Only)		
Type		Equivalent time sampler
Bandwidth	50 kHz to 450 MHz: -3 dB to +1 dB	Low frequency -3 dB point is 500 Hz.
Rise Time		500 ps (20-80%), 775 ps (10-90%)
Aberrations		< 10%, 800 mV step
Time Base Jitter		< 200 ps peak-to-peak

Table A-1: Electrical specifications (cont.)

Characteristic	Performance requirement	Reference information
Jitter Attenuation		
10 Hz HPF		< 10% for frequencies > 20 Hz. -3 dB at approximately 10 Hz.
100 Hz HPF		< 10% for frequencies > 300 Hz. -3 dB at approximately 100 Hz.
1 kHz HPF		< 10% for frequencies > 3 kHz. -3 dB at approximately 1 kHz. Up to 3 dB jitter gain from 2-4 kHz.
Display Modes		
Overlay		Overlays bits 0-9 of a serial word to form each Eye opening.
10-Eye		Parades bits 0-9 in a 10-Eye display.
Deflection Factor		
Vertical	800 mV \pm 5% with an 800 mV p-p input	
Horizontal		
Overlay Mode	1 ns/div \pm 3%	
10-Eye Mode	3 ns/div \pm 3%	
Mag On	500 ps/div \pm 3%	
Jitter Display (WFM 601M Only)		
Type		Demodulated recovered clock.
Digital Readout		
Accuracy		0.05 UI \pm 10% of reading.
Dynamic Range		
Alignment Jitter		2.4 UI p-p
Timing Jitter		9.0 UI p-p
Resolution		
Alignment Jitter		0.02 UI
Timing Jitter		0.1 UI
-3 dB Bandwidth		
Alignment Jitter Bandwidth selection		10 Hz to 5 MHz 1 kHz to 5 MHz 10 kHz to 5 MHz 100 kHz to 5 MHz
Timing Jitter		10 Hz to 5 MHz
Jitter Waveform		
Accuracy		\pm 10%

Table A-1: Electrical specifications (cont.)

Characteristic	Performance requirement	Reference information
Dynamic Range		10 UI p-p
Deflection Factor		
Horizontal		Four modes available: 1 Line, 2 Line 1 Field, 2 Field
Vertical		
X1		1 UI/div \pm 5%
X5		0.2 UI/div \pm 10%
X10		0.1 UI/div \pm 20%
-3 dB Bandwidths		
Bandwidth Selection		10 Hz to 5 MHz 1 kHz to 5 MHz 10 kHz to 5 MHz 100 kHz to 5 MHz
Jitter Output (WFM 601M Only)		120 mV/UI \pm 10% into 75 Ω load.
Signal Level & Cable Length Detector (WFM 601E and WFM 601M Only)		
Cable Length		
Accuracy		10 meters \pm 10% of reading (Belden 8281 cable).
Resolution		5 meters
Dynamic Range		0 to 400 meters (Belden 8281 cable)
Source Signal Level		
Accuracy		\pm 0.5 dB for cable lengths from 0-100 meters (Belden 8281)
Resolution		0.25 dB
Dynamic Range		\pm 3 dB
Cable Types		Supported cable types: Belden 8281 Belden 1694A Belden 1505A
Video Error Detection		
Type		Active picture and full field with field rate resolution. Uses EDH (Error Detection and Handling) system based on CRC check-word. Complies with SMPTE RP165.
Reporting Means		Front-panel ALARM indicator, rear-panel TTL line, and CRT readout.
Error Statistics		Asynchronous errored seconds. Active picture and full field statistics are separately compiled.

Table A-1: Electrical specifications (cont.)

Characteristic	Performance requirement	Reference information
Diagnostics		
Embedded Audio		Identifies the presence of up to 16 channels of AES/EBU digital audio.
Ancillary Data		Identifies the presence of ancillary data (other than audio and EDH) and indicates if a checksum error has occurred.
Bit Activity		Indicates if any of the 10 data bits are always high or low during the active picture for an entire field.
Line Rate		Indicates whether the signal is 525 or 625 line.
Format Errors		Warns that a serial signal format error has occurred for the following error types: <ul style="list-style-type: none"> ■ SAV placed incorrectly relative to EAV. ■ Line length error. ■ Field length error. ■ Reserved values used improperly. ■ ANC data checksum error. ■ ANC data parity error.
Signal Lost		Reports absence of the serial video signal.
Digital Data Value Cursor and Listing (WFM 601M Only)		
Digital Waveform		Non-interpolated waveform display. Cursor identifies selected sample value (hexidecimal, decimal, binary). Cross-hair cursor inserted on picture monitor output shows selected line and sample. Vertical and horizontal shift of picture monitor output when selecting blanking interval line and sample values.
Data Mode		Displays interleaved data stream sequentially with 31 samples per screen width. Cursor identifies selected sample value.
Video Mode		Displays Y, Cb, Cr data streams separately. Channels are selected with VIDEO IN buttons. Cursor identifies the selected sample value.
Digital List		Sequential list of sample values in table format. Cursor identifies selected sample. VIDEO mode identifies samples as Y, Cb, Cr.
External Reference		
Input		Analog composite video or black burst.
Maximum Operating Input Voltage		-1.8 V to +2.2 V, DC plus peak AC
Absolute Maximum Input Voltage		-8.5 V to +8.5 V, DC plus peak AC
DC Input Impedance		≥ 20 kΩ

Table A-1: Electrical specifications (cont.)

Characteristic	Performance requirement	Reference information
Return Loss		≥ 40 dB to 6 MHz; typically ≥ 46 dB to 6 MHz, ≥ 40 dB to 10 MHz.
Waveform Horizontal Deflection Sweep	<u>Internal Synchronization:</u> Proper horizontal and vertical synchronization with a component digital signal conforming to CCIR Rec. 601/656 and SMPTE 125M. <u>External Synchronization:</u> Proper horizontal and vertical synchronization with a composite sync signal of approximate line and field rate.	Sweep Length: ≈ 12 divisions Sweep free runs without input
Sweep Timing Accuracy	1 Line: $5 \mu\text{s/division} \pm 1\%$ 2 Line: $10 \mu\text{s/division} \pm 1\%$	1 Field displays one full field, including field rate sync. 2 Field displays two full fields and the field rate sync between them.
Sweep Linearity	$\pm 1\%$	
Magnified Sweep Accuracy	1 Line: $0.2 \mu\text{s/division} \pm 1\%$ 2 Line: $1.0 \mu\text{s/division} \pm 1\%$	
Magnified Sweep Linearity	$\pm 1\%$	
Timing Cursors	Accuracy: $\pm 1\%$	$\pm 0.5\%$ over 20–30° C
Horizontal Position Range	Any portion of the synchronized sweep can be positioned on screen in all sweep modes	
Analog Audio Mode (WFM 601A Only) Input		DC coupled, differential input, 20 k Ω input impedance.
Full Scale Selection		0, 4, 8, and 12 dBu full scale, menu selectable
Full Scale Accuracy	± 0.5 dB at 1 kHz	
Bandwidth	-3 dB ≥ 500 kHz using a leveled sine wave.	
X and Y Input Phase Matching	$\leq 1^\circ$, 20 Hz–20 kHz	
Maximum Input Voltage		± 8 V peak, measured to chassis ground
Calibrator Waveform Square Wave	Amplitude: 700 mV $\pm 1\%$ Frequency: 100 kHz $\pm 0.1\%$	Crystal-controlled 10 μs square wave
Component Vector Mode Vertical Bandwidth		≥ 1.0 MHz
Horizontal to Vertical Bandwidth Matching	$\leq 2^\circ$ at 500 kHz and 2 MHz	
Vertical Gain Accuracy	$\pm 1\%$	

Table A-1: Electrical specifications (cont.)

Characteristic	Performance requirement	Reference information
Horizontal Gain Accuracy	$\pm 1\%$	
Display to Graticule Registration	≤ 0.25 box with the color bar black, display dot centered in target	
Electronic Graticule Shape		Minimal visible gaps or tails at corners of target boxes
Vector Display		P_B is displayed on horizontal axis and P_R is displayed on vertical axis.
Lightning and Diamond Mode		
Vertical Gain Accuracy	$\pm 2\%$	
Electronic Graticule Display		
Diamond		GBR Deflection axis indicated.
Lightning		Y is displayed vertically. P_B is displayed horizontally on top half of display. P_R is displayed horizontally on bottom half of display.
RGB Gamut Error Indication		
Detection Level	Positive detection level = 735 mV ± 7 mV (nominally 105% of legal RGB). Negative Detection level = -35 mV ± 7 mV.	
Arrowhead Mode (NTSC/PAL Composite Limit Display Mode)		
Signal to Graticule Registration		Color bar black is positioned in the center of 7.5 IRE box within $\leq .25$ box width.
Signal to Graticule Accuracy (PAL values in parenthesis)	± 2 IRE, 100 IRE and 131 IRE (± 2 , 700 mV)	
Composite Limit Cursor Accuracy (PAL values in parenthesis)		$\pm 2\%$ at 100, 110, 120, 131 IRE (700 and 950 mV)
Composite Limit Detection Level Accuracy (PAL values in parenthesis)	Detection level = 102% $\pm 3\%$ of cursor level	Detection level can be set to 100, 110, 120, or 131 IRE (700 or 950 mV PAL)
Bowtie Mode		
Common Mode Rejection Ratio		≥ 34 dB at 2.5 MHz
Accuracy		$\pm 3\%$
Interchannel Timing Match		± 2.0 ns
Picture Monitor Outputs		
Signal Format		EBU/N10 or RGB, menu selectable.

Table A-1: Electrical specifications (cont.)

Characteristic	Performance requirement	Reference information
Active Video Accuracy		
WFM 601M	700 mV \pm 1% peak-to-peak (Y-P _B -P _R mode)	Typically < \pm 2% for RGB mode.
WFM 601E and WFM 601A	Typically 700 mV \pm 1% peak-to-peak (Y-P _B -P _R mode)	
Black (Blanking) Output Level	0 mV \pm 35 mV	
Frequency Response		Y to 5.75 MHz: \pm 1% P _B and P _R to 2.75 MHz: \pm 1%
Non-Linearity		\leq 0.5%
Group Delay Error		Y at 5.75 MHz: \leq 10 ns P _B and P _R at 2.75 MHz: \leq 20 ns
Interchannel Timing Match		Y-to-P _B and Y-to-P _R \pm 5.0 ns
Sync Amplitude Accuracy		300 mV \pm 10% Analog sync is inserted on Y channel only (G channel only in RGB mode).
Sync to Video Timing		525 line rate: 9.037 μ s \pm 0.050 μ s 625 line rate: 9.777 μ s \pm 0.050 μ s
Return Loss		50 kHz to 5 MHz: \geq 40 dB

Table A-2: CRT display

Characteristic	Performance requirement	Reference information
CRT Viewing Area		80 \times 100 mm Horizontal: 12.5 divisions Vertical: 1.19 V
Accelerating Potential		Nominally 13.75 kV
Trace Rotation Range	$> \pm 1^\circ$ from horizontal	Total adjustment range is typically $\geq 8^\circ$.
Graticule		Internal with variable illumination

Table A-3: AC power source

Characteristic	Description	Reference information
Electrical Rating		90 – 250 V, 50/60 Hz, 1.5 A maximum ; Continuous range from 90 to 250 VAC
Supply Type		Single Phase
Supply Connection		Detachable cord set
Power Consumption		< 115 VA (75 watts)

Table A-4: Environmental characteristics

Characteristic	Standard	Reference information
Vibration	Military Specification: Mil-T-28800D, Paragraph 1.2.2, Class 3	5 minutes at 5 – 15 Hz with 0.060 inch displacement 5 minutes at 15 – 25 Hz with 0.040 inch displacement 5 minutes at 25 – 55 Hz with 0.020 inch displacement
Mechanical Shock	Non-operating: 50 g 1/2 sine, 11 ms duration, 3 shocks per surface (18 total)	
Transportation	Qualified under NSTA Test Procedure 1A, Category II	24 inch drop
Humidity	Proper operation at 95% +0, -5% Relative Humidity	Do not operate with visible moisture on the circuit boards.

Table A-5: Physical characteristics

Characteristic	Standard
Dimensions	Height: 133.4 mm (5.25 in) Width: 215.9 mm (8.5 in) Depth: 460.4 mm (18.125 in)
Weight	Net: 3.8 kg (8 lbs) Shipping: 7.2 kg (15.7 lbs) approximate

Table A-6: Safety standards

Characteristic	Standard
U.S. Nationally Recognized Testing Laboratory Listing	ANSI/ISA S82.01 - Safety Standard for Electrical and Electronic Test, Measuring, Controlling, and Related Equipment, 1994.
Canadian Certification	CAN/CSA C22.2 No. 1010.1 - Safety Requirements for Electrical Equipment for Measurement, Control, and Laboratory Use.
European Union Compliance	Low Voltage Directive 73/23/EEC, Amended by 93/68/EEC IEC1010-1 - Safety Requirements for Electrical Equipment for Measurement, Control, and Laboratory Use.
Additional Compliance	UL3111-1 - Standard for Electrical Measuring and Test Equipment IEC1010-1 - Safety Requirements for Electrical Equipment for Measurement, Control, and Laboratory Use.

Table A-7: Safety certification compliance

Characteristic	Standard
Temperature (operating)	0° to +40° C
Altitude (operating)	2000 meters
Equipment Type	Test and Measuring
Equipment Class	Class I: Grounded product (as defined in IEC 1010-1, Annex H)
Overvoltage Category	Overvoltage Category II (as defined in IEC 1010-1, Annex J). Note: Rated for indoor use only. Category Examples of Products in this Category: CAT III Distribution-level mains, fixed installation CAT II Local-level mains, appliances, portable equipment CAT I Signal levels in special equipment or parts of equipment, telecommunications, electronics
Pollution Degree	Pollution Degree 2: Do not operate in environments where conductive pollutants may be present.

Table A-8: Certifications and compliances

Characteristic	Standard
EC Declaration of Conformity	<p>Meets intent of Directive 89/336/EEC for Electromagnetic Compatibility and Low Voltage Directive 73/23/ECC for Product Safety. Compliance was demonstrated to the following specifications as listed in the Official Journal of the European Communities:</p> <p>EMC Directive 89/336/EEC^{1,2}:</p> <p>EN 55011 Class A Radiated and Conducted Emissions</p> <p>EN 50081-1 Emissions:</p> <p> EN 60555-2 AC Power Line Harmonic Emissions</p> <p>EN 50082-1 Immunity:</p> <p> IEC 801-2 Electrostatic Discharge Immunity</p> <p> IEC 801-3 RF Electromagnetic Field Immunity</p> <p> IEC 801-4 Electrical Fast Transient/Burst Immunity</p> <p> IEC 801-5 Power Line Surge Immunity</p> <p>Low Voltage Directive 73/23/EEC:</p> <p>EN 61010-1 Safety requirements for electrical equipment for measurement, control, and laboratory use</p> <p>¹ Use high-quality shielded cables.</p> <p>² When installed in any of the following Tektronix instrument enclosures: 1700F00 (Tektronix part number 437-0100-04) 1700F02 (Tektronix part number 437-0018-07) 1700F05 (Tektronix part number 437-0095-04)</p>

Appendix B: Remote Operation

The waveform monitor has two multi-pin connectors on the rear panel that provide different types of remote control. The RS-232 port provides for automated calibration using a procedure contained in the Service Manual. In a future firmware release, the RS-232 port will provide remote control using a SCPI command set. The REMOTE connector provides a way to monitor signal errors and to load or save Presets. It also provides two audio channel inputs for the WFM 601A.

RS-232 Connector

The RS-232 connector is a 9-pin D-type connector that provides a remote verification interface. Figure B-1 shows the pin assignments and the communication parameters for the RS-232 interface.

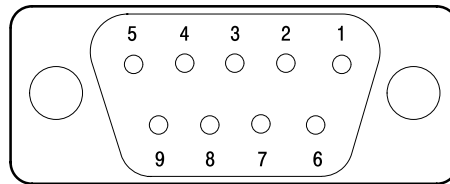

Communication parameters

Baud: 9600

Data bits: 8

Stop bits: 1

Parity: None

Flow control: Xon/Xoff

Pin Number	Data Connection
1	DCD (Received line signal detector)
2	RXD (Received data)
3	TXD (Transmitted data)
4	DTR (DTE ready)
5	Signal ground
6	DCR (DCE ready)
7	RTS (Request to send)
8	CTS (Clear to send)
9	Not connected

Figure B-1: Pin assignments for the RS-232 connector

Remote Connector

The rear-panel REMOTE connector is a 25-pin, D-type connector that allows low-level remote control and audio channel inputs. Use the RS-232 interface for control using SCPI commands sent from a PC controller.

Preset Control

The Remote connector provides control of Presets and monitoring of line select and video alarm events. Eight of the Presets (stored front-panel settings) can be stored or recalled remotely.

When STORE (pin 25) is grounded along with one of the preset pins, the current front-panel settings are stored at the selected Preset location.

Line Select Strobe

Pin 15 outputs an active-low TTL pulse during selected lines when in Line Select modes. Use this signal as a trigger for a logic analyzer or oscilloscope.

Serial Video and Gamut Alarm

Pin 16 outputs an active-low TTL level whenever the front-panel ALARM light is illuminated or when a gamut alarm occurs. You must enable the gamut alarms using the Configure menu. See pages for 3–10 and 3–11 for more information on enabling the Gamut and Serial alarms.

Remote Connector Pin Assignments

Pin assignments for the REMOTE connector are shown in Figure B–2 and described in Table B–1. You enable functions by ground closures (TTL lows) on specified pins. Functions with “overbars” indicate an active low state.

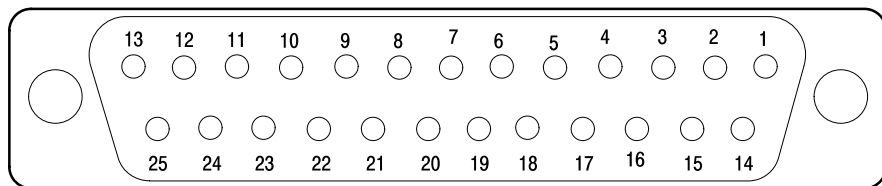

Figure B–2: Pin assignments for the REMOTE connector

Table B–1: Remote connector pin assignments and functions

Pin number	Function	Signal requirement	Miscellaneous information
1	Not Used	No connection allowed	
2	Ground	TTL ground	
3	Not Used	No connection allowed	
4	Not Used	No connection allowed	
5	Ground	TTL ground	
6	Not Used	No connection allowed	
7	Ground	TTL ground	
8	+Y Audio Input	Audio input, +8 V peak	(WFM 601A Only) The +Y and –Y inputs can function as differential inputs for a common signal.
9	–Y Audio Input	Audio input, –8 V peak	(WFM 601A Only)
10	+X Audio Input	Audio input, +8 V peak	(WFM 601A Only) The +X and –X inputs can function as differential inputs for a common signal.

Table B-1: Remote connector pin assignments and functions (cont.)

Pin number	Function	Signal requirement	Miscellaneous information
11	-X Audio Input	Audio input, -8 V peak	(WFM 601A Only)
12	Not Used	No connection allowed	
13	Not Used	No connection allowed	
14	Ground	TTL ground	
15	$\overline{\text{Line Strobe}}$	In Line Select Modes, true, low, during selected video lines	
16	$\overline{\text{Serial Video Alarm}}$	True low. Low pulse when a serial error or a gamut alarm occurs	You must enable the gamut alarm (page 3-10) and serial alarm (page 3-11) in the Configure menu.
17	Preset 1	Ground (TTL low)	Recalls the stored Preset from this location, or selects the Preset 1 memory location to store the current front-panel settings. See the pin 25 description.
18	Preset 2	Ground (TTL low)	Recalls the stored Preset from this location, or selects the Preset 1 memory location to store the current front-panel settings. See the pin 25 description.
19	Preset 3	Ground (TTL low)	Recalls the stored Preset from this location, or selects the Preset 1 memory location to store the current front-panel settings. See the pin 25 description.
20	Preset 4	Ground (TTL low)	Recalls the stored Preset from this location, or selects the Preset 1 memory location to store the current front-panel settings. See the pin 25 description.
21	Preset 5	Ground (TTL low)	Recalls the stored Preset from this location, or selects the Preset 1 memory location to store the current front-panel settings. See the pin 25 description.
22	Preset 6	Ground (TTL low)	Recalls the stored Preset from this location, or selects the Preset 1 memory location to store the current front-panel settings. See the pin 25 description.
23	Preset 7	Ground (TTL low)	Recalls the stored Preset from this location, or selects the Preset 1 memory location to store the current front-panel settings. See the pin 25 description.

Table B-1: Remote connector pin assignments and functions (cont.)

Pin number	Function	Signal requirement	Miscellaneous information
24	Preset 8	Ground (TTL low)	Recalls the stored Preset from this location, or selects the Preset 1 memory location to store the current front-panel settings. See the pin 25 description.
25	Store	Ground (TTL low)	Grounding $\overline{\text{STORE}}$ enables storage of instrument settings. When $\overline{\text{STORE}}$ transitions low when one of the $\overline{\text{PRESETS}}$ is low, the current front-panel settings are stored in that Preset location.

Appendix C: Remote Command Set

This section describes the remote command set for the waveform monitor and provides examples of typical usage. The remote command set is a versatile and convenient interface that conforms to industry standards for programmable instruments.

The waveform monitor permits remote operation through the RS-232 port on the rear panel. Remote communication parameters are described in *Appendix B: Remote Operation*.

The waveform monitor was not designed to be machine-driven; consequently, characters can be dropped if they are input while the processor is carrying out other operations. To compensate, the code for a remote communications retry program has been included at the end of this section. This program ensures that characters are not dropped when they are input into the waveform monitor. You may type commands from your work station with or without the program; however, if you want to create machine-driven test and measurement protocols, use the retry program provided.

The symbols used in the descriptions of the remote commands are shown in Table C-1.

Table C-1: Symbols used in this section

Symbol	Meaning
< >	Group; one element is required
[]	Group; elements are optional
	OR; separates a list of arguments

The commands in this section are arranged alphabetically by groups of similar commands. Commands with similar syntax are explained in tables with argument options and comments about each command. Examples of possible command strings and responses are then listed below the tables. The rest of the commands are described individually with examples of syntax and typical usage given for each command.

In the following descriptions, the capitalized letters in the *Syntax* descriptions are the minimum letters necessary for the waveform monitor to recognize the command. Commands and arguments are not case sensitive.

Most commands have a query form. Generally, you can query at any point along a command string back to the root but you can not query arguments. In the following command descriptions, queries are given below the command syntax

in the *Syntax* sections. Query examples and typical responses are given in the *Response* sections.

Cable Measurement Commands

The commands in this section provide control of the cable measurements available in the Serial status mode. You access these measurements differently depending on whether your waveform monitor has V1.X or V2.X (or latter) firmware. With either version, you must first enter the Serial mode by sending the command MENU:SERial. This is equivalent to pressing the SERIAL button on the front panel.

For waveform monitors with version V1.X firmware, cable and signal strength commands are active after sending the command SERIAL:MENU STATUS. For version V2.X firmware, send the command SERIAL:MENU CABLE. This is equivalent to pressing the side bezel button to select the CABLE menu. Cable measurements are active only when the SERIAL STATUS menu (V1.X) or SERIAL CABLE menu (V2.X) are selected.

Use the SLM: commands to select the type of cable your installation uses and to query the waveform monitor for cable type and length. You can also query for the computed signal level of a monitored signal. Not all commands work with all versions of firmware.

SLM:CABle <B8281 | B1694 | B1505> (WFM 601E and WFM 601M Only)

Selects the cable type for use by the Signal Level and Approx Cable Length measurements. This selection corresponds to the Cable Type selection in the SERIAL menu. This command works with V1.X and V2.X firmware.

Syntax	SLM:CABle <B8281 B1694 B1505> SLM[:CABle]?
Arguments	<B8281 B1694 B1505>
Examples	slm:cab b1694
Returns	slm? :SLM:LEVEL 4.75 dB;LENGTH 20 Meters;CABLE B1694; SOURCE 95 PERCENT slm:cab? :SLM:CABLE B1694

SLM:SOURCE? (WFM 601E and WFM 601M Only)

Returns the power (Signal Level readout) of the source as a percent of an 800 mV signal. This command works only with V2.X firmware. See the corresponding V1.X firmware command SLM:LEVEL.

Syntax SLM:[SOURCE]?

Arguments None

Examples slm:source?

Returns :SLM:SOURCE 95 PERCENT

SLM:RCVR? (WFM 601E and WFM 601M Only)

Returns a dB value for the power lost in the cable. This command works only with V2.X firmware. To ensure a correct measurement, use the command SLM:CABLE to indicate the cable type you are using.

Syntax SLM:[RCVR]?

Arguments None

Examples slm:rcvr?

Returns :SLM:RCVR 2 dB

SLM:LEVEL? (WFM 601E and WFM 601M Only)

Returns the power (Signal Level readout) of the source in decibels with reference to an 800 mV signal. This command works only with V1.X firmware. See the corresponding V2.X firmware command SLM:SOURCE.

The Signal Level value is derived as $LEVEL = 20 \text{ Log} (\text{Estimated Source Power}) / 800 \text{ mV}$. A negative sign indicates that the received power is below 800 mV.

Syntax	SLM[:LEVEL]?
Arguments	None
Examples	slm:level?
Returns	SLM:LEVEL 4.75 dB

SLM:LENGTH? (WFM 601E and WFM 601M Only)

Returns the Approx Cable Length measurement, based on the SLM:CAB setting. Cable length is the amount of cable between the video source and the waveform monitor. This command works for firmware version V1.X and V2.X.

Syntax	SLM[:LENGTH]?
Arguments	None
Examples	slm:length?
Returns	SLM:LENGTH 20 METERS

Configuration Commands

The commands in this section allow you make the following changes to the waveform monitor:

- Select the source of your reference signal
- Select a specific mode for different displays (for example, select the Lightning mode when in the Vector display)
- Set parameters for various displays

Most of these commands correspond to the selections available from the CONFIG menu on the waveform monitor.

REFERENCE: MODE <INT | EXT>

Selects either the internal serial digital or external composite video for the synchronization reference.

Syntax REFERENCE: MODE <INT | EXT>
REFERENCE: MODE?

Arguments <INT | EXT>

Examples refe:mode int

Returns refe:mode?
:REFERENCE:MODE INTERNAL

ARROWhead:LIMIT:PAL <MV_700 | MV_950>

Sets the PAL gamut limit amplitude on the ARROWHEAD graticule. The gamut limit triggers an alarm when exceeded by the input signal. This selection corresponds to the choices available under GAMUT in the CONFIG GAMUT menu.

Use the command DISPLAY:SINGLE:GAMut to enable the GAMUT display.

Syntax	ARROWhead:LIMIT: PAL <MV_700 MV_950> ARROWhead[:LIMIT :LIMIT:PAL]?
Arguments	<MV_700 MV_950>
Examples	arrow:limit:PAL mv_950 arrow:limit:pal MV_700
Returns	arrow:limit:pal? :ARROWHEAD:LIMIT:PAL MV_700

ARROWhead:LIMIT:NTSC <IRE_100 | IRE_110 | IRE_120 | IRE_131>

Sets the NTSC gamut limit on the ARROWHEAD graticule. The gamut limit triggers an alarm when exceeded by the input signal. These selections correspond to the choices available under GAMUT in the CONFIG GAMUT menu.

Use the command DISPLAY:SINGLE:GAMut to enable the GAMUT display.

Syntax	ARROWhead:LIMIT:NTSC <IRE_100 IRE_110 IRE_120 IRE_131> ARROWhead[:LIMIT :LIMIT:NTSC]?
Arguments	<IRE_100 IRE_110 IRE_120 IRE_131>
Examples	arrow:limit:ntsc ire_120 arrow:limit:ntsc ire_131
Returns	arrow:limit:ntsc? :ARROWHEAD:LIMIT:NTSC IRE_131

ARROWhead:FORMat <NTSC | PAL | AUTO>

Sets the video format for theARROWHEAD graticule.

Use the command DISPlay:SINGLE:GAMut to enable the GAMUT display. Use the command ARROW:LIMIT:NTSC or ARROW:LIMIT:PAL to set the gamut alarm setting.

Syntax ARROWhead:FORMat <NTSC | PAL | AUTO>
ARRPWhed[:FORMat]?

Arguments <NTSC | PAL | AUTO>

Examples arrow:form:ntsc

Returns arrow:form?
:ARROWHEAD:FORMAT NTSC

GAMut:GRATicule <ARROWhead | DIAMond>

Selects either the Arrowhead or Diamond display for displaying the signal gamut. The Arrowhead display checks the composite gamut and the Diamond display checks the RGB gamut.

Use the command DISPlay:SINGLE:GAMut to enable the Gamut display mode.

Syntax GAMut:GRATicule <ARROWhead | DIAMond>
GAMut[:GRATicule]?

Arguments <ARROWhead | DIAMond>

Examples display:single gamut
gam:grat dia

Returns gam:grat?
:GAMUT:GRATICULE DIAMOND

GAMut:ALarm:TRIGger <NONE | CMPST | RGB | BOTH>

Determines the type of gamut error that will trigger a gamut alarm. This command corresponds to the selections found under GAMUT CHECK in the GAMUT CONFIG menu.

Syntax GAMut:ALarm:TRIGger <NONE | CMPST | RGB | BOTH>
GAMut[:ALarm | :ALarm:TRIGger]?

Arguments <NONE | CMPST | RGB | BOTH>

Examples gam:al:trig both

Returns gam:al:trig?
:GAMUT:ALARM:TRIGGER BOTH

GAMut:ALarm:DISPlay <SCRN | PICT | BOTH>

Determines where the gamut alarm indicator is displayed. This command corresponds to the selections found under ALARM DISP in the GAMUT CONFIG menu.

Syntax GAMut:ALarm:DISPlay <SCRN | PICT | BOTH>
GAMut[:ALarm | :ALarm:DISPlay]?

Arguments <SCRN | PICT | BOTH>

Examples gam:al:disp pict

Returns gam:al:disp?
:GAMUT:ALARM:DISPLAY PICT

STANDARD <LINES_525 | LINES_625 | AUTO>

Sets the scanning standard that the instrument expects to NTSC (525 lines) or PAL (625 lines). When in the AUTO mode, the waveform monitor automatically senses the standard of the input signal. This selection corresponds to the choices available under STANDARD in the CONFIG FORMAT menu.

Syntax STANDard <LINES_525 | LINES_625 | AUTO>
STANDard?

Arguments <LINES_525 | LINES_625 | AUTO>

Examples stand auto

Returns stand?
STANDARD AUTO

VECTor:BARs <B100 | B75>

Selects the 75% or 100% graticule for the Lightning and Vector modes. The graticule must match the type of the selected input signal. This selection corresponds to the choices available under COLOR BARS in the CONFIG WFM/VEC menu.

Syntax VECTor:BARs <B100 | B75>
VECTor[:BARs]?

Arguments <B100 | B75>

Examples vec:bars b75

Returns vec:bars?
:VECTOR:BARs B75

VECtor:GRATICule <LTNG | VECtor>

Selects either the Lightning or Vector display. Use the command DISP:SINGLE:VEC (page C-25) to enable the vector display modes.

Syntax	VECtor:GRATICule <LTNG VECtor> VECtor[:GRATICule]?
Arguments	<LTNG VECtor>
Examples	vec:grat ltng
Returns	vec:grat? :VECTOR:GRATICULE LIGHTNING

SERial:MENU <STATUS | FORM | CABLE>

Sets the Serial Format display to the Status, Format, or Cable screens. The STATUS screen includes information such as signal presence, line rate, and error rate. The FORMAT screen displays the results of several data format checks. The CABLE screen displays the calculated strength of the input signal and the cable length.

The CABLE argument is valid only with firmware V2.X and later. With firmware V1.X, the cable and signal strength readouts are available on the STATUS screen.

Syntax	SERial:MENU <STATUS FORM CABLE> SERial[:MENU]?
Arguments	<STATUS FORM CABLE>
Examples	menu serial serial:menu form ser:menu status
Returns	ser:menu? :SERIAL:MENU STATUS

SERial:DISPlay <RGB | YPbPr>

Sets the display to native YPbPr or transcoded RGB for the Waveform and Parade displays. The monitor outputs are not affected. This selection corresponds to the choices available under WFM AS in the CONFIG WFM/VEC menu.

Syntax SERial:DISPlay <RGB | YPbPr>
SERial[:DISPlay]?

Arguments <RGB | YPbPr>

Examples ser:disp RGB
SER:DISP ypbpr

Returns ser:disp?
:SERIAL:DISPLAY YPBPR

SERial:MONitor <GBR | YPbPr>

Sets the format of the rear panel MONITOR OUTputs to YPbPr or GBR. This selection corresponds to the choices available under MON OUT AS in the CONFIG FORMAT menu.

Syntax SERial:MONitor <GBR | YPbPr>
SERial[:MONitor]?

Arguments <GBR | YPbPr>

Examples ser:mon gbr
SERIAL:MON YPBPR

Returns ser:mon?
:SERIAL:MONITOR YPBPR

SERial:EAVSAV <PASS | STRIP>

This command permits stripping of the END/START of ACTIVE VIDEO information from the displayed signal. This selection corresponds to the choices available under EAV-SAV in the CONFIG WFM/VEC menu.

Syntax	SERial:EAVSAV <PASS STRIP> SERial[:EAVSAV]?
Arguments	<PASS STRIP>
Examples	ser:eavsav pass serial:eavsav strip
Returns	ser:eavsav? :SERIAL:EAVSAV STRIP

SERial:ALarm:<error type> <alarm setting>

These commands select or disable checking for several types of format errors and correspond to the error selections available in the CONFIG SER ALARM menu. Table C-2 lists the SERial:ALarm error type commands <error type> and options <alarm setting>.

Use the UIMENU:CONFIGSEL SERIALARM command (page C-14) to put the waveform monitor into the serial alarm mode before using this command.

Syntax	SERial:ALarm:<error type> <alarm setting> SERial[:ALarm :ALarm:<error type>]?
Arguments	:<error type> <alarm setting>

Table C-2: SERIAL:ALarm: commands and options

:<error type>	<alarm setting>	Remarks
FMTERR (Format error)	ALARM OFF	Sets the format error alarm on or off. When on, a Serial Format error lights the Alarm LED on the front panel. This selection corresponds to the choices available under FMT ERROR in the CONFIG SER ALARM menu.
FFCRC (Full-field cyclic redundancy check)	ALARM OFF	Sets the full-field cyclic redundancy check (FFCRC) error alarm on or off. When on, a full-field CRC error lights the Alarm LED on the front panel. This selection corresponds to the choices available under FULL FIELD CRC ERROR in the CONFIG SER ALARM menu.
APCRC (Active picture cyclic redundancy check)	ALARM OFF	Sets the active picture CRC error alarm on or off. When on, an active picture CRC error lights the Alarm LED on the front panel. This selection corresponds to the choices available under ACTIVE PIC CRC ERROR in the CONFIG SER menu.

Examples
 ser:alarm:ffcrc off
 ser:alarm:fmtterr alarm
 serial:alarm:apcrc alarm

Returns
 serial:alarm:apcrc?
 :SERIAL:ALARM:APCRC ALARM
 serial:alarm?
 :SERIAL:ALARM:FMTERR ALARM;FFCRC OFF;APCRC ALARM

UIMENU:<command> <options>

These commands provide access to the CONFIG and CRT menus, enable the PREset functions, and clear the menu display. Table C-3 lists the UIMENU (User Interface menu) commands and argument options.

Syntax
 UIMENU:<command> <options>
 UIMENU[:<command>]?

Arguments
 :<command> <options>

Table C-3: UIMENU: commands and options

:<command>	<options>	Remarks
STICKY	FILTer CURSor LINESelect GAIN CONFIG	Sets the selection to the named subsystem when in the UIMENU mode. The Sticky function is accessible from the front panel by pressing a menu button before pressing the CONFIG button.
PREset	ON OFF	Enables or disables UIMENU presets. Use the PRESET commands to recall, store, and name presets.
CONFIG	ON OFF	Selects the CONFIG menu for display. Use the CONFIGSEL command to select a particular display or mode to configure.
CONFIGFCT	ON OFF	Turns on or off the USER INTERFACE MENU (also accessible from the bezel knob).
CONFIGSEL	WFMVEC EY JIT SERIALARM GAM CAL	Selects a category in the CONFIG menu. This selection is equivalent to turning the bezel knob in the CONFIG menu. Use the CONFIG command to enable the CONFIG menu.
CRTADJUST	READ TRACE DISPLAY	Enables the CRT adjustments on the current display, if allowed.

Examples

```
uimenu:preset off
uimenu:config on
uimenu:configsel wfmvec
uimenu:configfct on
```

Returns

```
uimenu?
:UIMENU:STICKY FILTER;PRESET OFF;CONFIG ON;CONFIGFCT
ON;CONFIGSEL WFMVEC;CRTADJUST TRACE
uimenu:preset?
:UIMENU:PRESET OFF
```

Cursor Commands

The commands in this section allow you to select and move the voltage and timing cursors on the waveform monitor. They also allow you to make measurements using the cursors.

CURsor:SElect <VOLT | TIME | VOLT_TIME | MARK | NONE>

Enables any one of the following cursor types:

- VOLT provides two voltage cursors and a track control.
- TIME provides two time cursors and a track control.
- MARK provides three amplitude markers.
- VOLT_TIME provides both VOLT and TIME cursors. Use CUR:CONTROL to select either the voltage or time cursors.

Syntax CURsor:SElect <VOLT | TIME | VOLT_TIME | MARK | NONE>
CURsor[:SElect]?

Arguments <VOLT | TIME | VOLT_TIME | MARK | NONE>

Examples cur:sel volt
cur:select mark
cursor:select volt_time

Returns cur?
:CURSOR:SELECT VOLT_TIME;CONTROL TIME
cursor:select?
:CURSOR:SELECT VOLT_TIME

CURsor:CONTROL <VOLT | TIME>

Selects either the VOLT or TIME cursor when the cursor type is both voltage and time. This command operates like the bezel button for selecting between voltage and time cursors when VOLT_TIME (or the front panel selection V+T) is enabled.

Syntax	CUR:CONTROL <VOLT TIME> CUR[:CONTROL]?
Arguments	<VOLT TIME>
Examples	cur:control time
Returns	cursor:control? :CURSOR:CONTROL TIME

MC:<ONE | TWO | THREE> <marker position>

Sets the position of the three amplitude markers over the voltage range of the displayed waveform. These selections correspond to the MARK1, MARK2, and MARK3 bezel knobs when MARK is enabled under the CURSOR menu.

The range of accepted values for the argument <marker position> is 548 to 3548.

Syntax	MC:<ONE TWO THREE> <marker position> MC[:ONE TWO THREE]?
Arguments	:<ONE TWO THREE> <marker position>
Examples	mc:three1838 mc:one 1200
Returns	mc? :MCURSORS:ONE 1200;TWO 2025;THREE 1838

<VC | TC>:<ONE | TWO> <voltage level | timing range>

Positions the voltage or timing cursors over the voltage range or timing base of the displayed waveform. When :TRACK is ON, moving one cursor moves the other cursor the same distance. Table C-4 describes the voltage and timing cursor positioning commands, arguments, and limits.

Syntax <VC | TC>:<ONE | TWO> <voltage level | timing range>
 <VC | TC>[:ONE | TWO]?

Arguments <voltage level | timing range>

Table C-4: Voltage and Timing Cursor positioning commands and options

Commands	Arguments	Limits
VC:<ONE TWO>	<voltage level>	0 – 4000
TC:<ONE TWO>	<timing range>	0 – 4000

Examples vc:one 3000
 tc:two 2136
 tc:one 1000

Returns tc?
 :TCURSORS:ONE 1000;TWO 2136;DIFFERENCE 1136;TRACK OFF

<TC | VC>:TRACK <ON | OFF>

Enables cursor tracking. When :TRACK is ON, moving one cursor moves the other cursor an equal amount in the same direction. Table C-5 describes the voltage and timing cursor tracking commands. Both options can be turned ON or OFF.

Use the Voltage and Timing Cursor positioning commands (page C-18) to move the cursors.

Syntax <TC | VC>:TRACK <ON | OFF>
<TC | VC>[:TRACK]?

Arguments <ON | OFF>

Table C-5: Voltage and Timing Cursor tracking commands and options

Commands	Arguments	Remarks
VC:TRACK	<ON OFF>	When on, the Voltage cursors move together to maintain the distance between them. Moving VC:ONE causes VC:TWO to move the same amount.
TC:TRACK	<ON OFF>	When on, the Timing cursors move together to maintain the distance between them. Moving TC:ONE causes TC:TWO to move the same amount.

Examples vc:track on
tc:track off

Returns tc:track?
:TCURSORS:TRACK OFF

Digital Waveform and Digital List Commands

The commands in this section allow you to change parameters for the Digital Waveform and Digital List displays.

DGTL? (WFM 601M Only)

***NOTE.** The values displayed when using this command are accurate only when the waveform monitor is in the Data List mode.*

Returns data for all DGTL display settings. For a description of each part of the returned data, refer to the associated command descriptions.

Syntax	DGTL?
Arguments	None
Examples	dgtl?
Returns	dgtl? :DGTL:VIDMODE VIDEO;FREEZE ON;BASE HEX;REGION ACTIVE;DATA:V0 528;V1 528;V2 528;V3 532;V4 532;V5 532;V6 532;V7_SELECTED 536;V8 536;V9 536;V10 536;V11 540;V12 540;V13 540;V14 540;:DGTL:VDATA:SELECTED 532;CB 536;Y0 536;CR 536;Y1 536

DGTL:REGion? (WFM 601M Only)

Returns the region of the video signal where the data cursor is located. Possible regions include active picture, horizontal blanking, and vertical blanking.

Syntax	DGTL:REGION?
Arguments	None
Examples	dgtl:region?
Returns	:DGTL:REGION ACTIVE

DGTL:DATA? (WFM 601M Only) DGTL:DATA:V#?

NOTE. The values displayed when using this command are accurate only when the waveform monitor is in the Data List mode.

DGTL:DATA? returns 15 data samples centered on the currently selected sample (see *LINESelect*: commands on page C-42). This region data corresponds to the data seen on the Digital Video display.

DGTL:DATA:V#? returns only the numbered sample from the 15 displayed, counting from the top down. Sample 7 is always the sample selected by the data cursor. This sample corresponds to V7 on the display.

Change the display mode to Digital List using the DISPLAY:SINGLE <display mode> command (page C-25) before using this command.

Syntax	DGTL:DATA? DGTL:DATA:V#?
Arguments	Include the letter <i>V</i> followed by an integer (0–14) for the line number (#) argument.
Examples	disp:single:dlist dgtl:data:v7?
Returns	dgtl:data:v7? :DGTL:DATA:V7 536

DGTL:VDATA? (WFM 601M Only)

NOTE. The values displayed when using this command are accurate only when the waveform monitor is in the Digital Waveform mode.

Returns the four demultiplexed data samples grouped with the currently selected sample (see *LINESelect*: commands on page C–42) The returned data corresponds to the data group containing the data cursor on the Digital Video display. Change the display mode to Digital Waveform (DISP:SINGLE DWFM on page C–25) before using this command.

Syntax	DGTL:VDATA?
Arguments	None
Examples	disp:single:dwfm dgtl:vdata?
Returns	dgtl:vdata? :DGTL:VDATA:SELECTED 536;CB 536;Y0 536;CR 536;Y1 536

DGTL:VIDmode <VIDEO | DATA> (WFM 601M Only)

Selects whether to display the raw data as a linear data sequence or as groups of four color difference values as they appear in the demultiplexed data: Cb, Y, Cr Y'.

Syntax	DGTL:VIDmode <VIDEO DATA> DGTL[:VIDmode]?
Arguments	<VIDEO DATA>
Examples	dgtl:video video
Returns	dgtl:vid? :DGTL:VIDMODE VIDEO

DGTL:FReeze <ON | OFF> (WFM 601M Only)

Selects between viewing frozen data (ON) or active data (OFF) on the Digital List display. Freeze the data to study transient events.

Syntax	DGTL:FREEZE <ON OFF> DGTL[:FREEZE]
Arguments	<ON OFF>
Examples	dgtl:freeze on
Returns	dgtl:fr? :DGTL:FREEZE ON

DGTL:BASE <HEX | DECIMAL | BINARY> (WFM 601M Only)

Displays the sample values in hexadecimal, binary or decimal format on the Digital List display.

Syntax DGTL:BASE <HEX | DECIMAL | BINARY>
DGTL[:BASE]?

Arguments <HEX | DECIMAL | BINARY>

Examples dgtl:base hex

Returns dgtl:base?
:DGTL:BASE HEX

Display Commands

The commands in this section allow you to select and set parameters for the display modes of the waveform monitor. You must use the VECtor:GRATicule and GAMut:GRATicule commands to select one of the two modes for the Vector and Gamut displays.

DISPlay:SINGLE <display mode>

Sets the display mode to one of those described in Table C–6. The table lists the mode each command invokes and indicates some of the commands described elsewhere in this section that relate to the command.

NOTE. The DISPlay:SINGLE:<display mode> command elicits no response when the waveform monitor is in the Multiple mode. You must first enter the Single display mode by disabling the Multiple mode from the waveform monitor, or by using the complete command string DISP:SINGLE <display mode>.

Syntax DISPlay:SINGLE <display mode>
DISPlay[:SINGLE]?

Arguments <display mode>

Table C–6: DISPLay:SINGLE commands

<display mode>	Selects	Remarks
WFM	Waveform	Use the command INPUT:SOU to select the A or B inputs, and use INPUT:CHA to select which of the RGB or YPbPr channels to display (page C–38).
VECtor	Vector or Lightning	Use the command VECtor:GRATicule to select the Lightning or Vector display (page C–11).
EYe	Eye	For the WFM 601M, use the command EYe:DISP to select the Eye or EQEye display. Use the command EYe:MODE to select Overlay or 10 Eye mode. Use the command EYe:CLO to set the clock high-pass filter (page C–33).
EQEYE	EQ Eye	Use for the WFM 601E only.
JITter	Jitter	Use the JITter commands to set jitter measurement parameters (page C–40).

Table C-6: DISPLAY:SINGLE commands (cont.)

<display mode>	Selects	Remarks
PIX	Picture	Use the commands DISPLAY:PIXB and DISPLAY:PIXC to set the blackness and contrast levels (page C-28).
GAMut	Diamond Arrowhead	Use the command GAMut:GRAT to select the DIAMOND or ARROW display (page C-8).
BOWtie	Bowtie	
AUDIO	Audio	Use the command GAIN:AUDIO (page C-35) to set the audio input gain level. Use the POS:<VERT HORZ> commands to position the Audio display (page C-45).
PARade	Parade	Use the command INPUT:SOU to select the A or B inputs and use INPUT:CHA to select which of the RGB or YPbPr channels to display (page C-38).
DLIST	Digital List	Use the command DGTL:VID to select the Video or Data modes (page C-23). Use the command DGTL:FR to view frozen or active data (page C-23).
DWFM	Digital Waveform	

Examples display:single wfm
 disp:single ey

Returns disp:single?
 :DISPLAY:SINGLE EYE

DISPLAY:INTENSITY:<display mode>:<line select mode> <intensity>

The DISPLAY:INTENSITY commands set the intensity of the <display mode> in the Normal, H1, or H15 Line Select modes. Intensity is an integer from -2047 to 1700. Table C-7 describes the <display mode>, <lineselect mode>, and <intensity> options.

Syntax DISPLAY:INTENSITY:<display mode>:<line select mode> <intensity>
 DISPLAY[:INTENSITY |
 :INTENSITY:<display mode> |
 :INTENSITY:<display mode>:<line select mode>]?

Arguments :<display mode>:<line select mode> <intensity>

Table C-7: DISPlay:INTENSITY command options

<display mode>	<line select mode>	<intensity>
WFM Sets the intensity of the Waveform display	<NORMal H1 H15> ¹	-2047 to 1700
VEC Sets the intensity of the Vector display	<NORMal H1 H15> ¹	-2047 to 1700
LTNG Sets the intensity of the Lightning display	<NORMal H1 H15> ¹	-2047 to 1700
EYe Sets the intensity of the Eye display	<NORMal H1 H15> ¹	-2047 to 1700

¹ When REF mode is set to Internal, the displayed 1H and 15H intensities both use the 15H intensity setting.

Examples disp:intensity:wfm:h1 1000

Returns display:intensity:wfm?
:DISPLAY:INTENSITY:WFM:H1 1000

DISPlay:INTENSITY:READ <intensity>

Sets the intensity of the on-screen readout text. Intensity is an integer from -2047 to 1700.

Syntax DISPlay:INTENSITY:READ <intensity>
DISPlay[:INTENSITY | :INTENSITY:READ]?

Arguments <intensity>

Examples displ:intensity:read 700

Returns display:intensity:read?
:DISPLAY:INTENSITY:READ 700

DISPlay:INTENSITY:AUDIO <intensity> (WFM 601A Only)

Sets the intensity of the on screen readout text. Intensity is an integer from -2047 to 1700.

Syntax DISPLay:INTENSITY:AUDIO <intensity>
DISPLay[:INTENSITY | :INTENSITY:AUDIO]?

Arguments <intensity>

Examples displ:intensity:audio 1000

Returns display:intensity:audio?
:DISPLAY:INTENSITY:AUDIO 1000

DISPlay:PIXC <contrast range>

Sets the contrast in the Picture display. The contrast value is an integer from -170 (low) to -1200 (high). The median value (-685) provides good contrast. This setting corresponds to the CONTRAST adjustment available after pressing the CRT MENU button in the Picture display.

Syntax DISPlay:PIXC <contrast range>
DISPlay[:PIXC]?

Arguments <contrast range>

Examples displ:pixc -700

Returns display:pixc?
:DISPLAY:PIXCONTRAST -700

DISPlay:PIXB <blackness range>

Sets the blackness level of the Picture display. The blackness value is the level of the picture that is considered to be the darkest black. The upper limit is +300 and the lower limit is -300. A setting less than zero can produce a light picture, while settings greater than 100 can produce a dark picture. This setting corre-

sponds to the BLACK LEVEL adjustment available when the CRT MENU button is pressed in the Picture display.

Syntax	DISPlay:PIXB <blackness range> DISPlay[:PIXB]?
Arguments	<blackness range>
Examples	displ:pixb 100
Returns	display:pixb? :DISPLAY:PIXBLACKNESS 100

DISPlay:TRACEROT <tracerotate>

Allows adjustment of trace rotation. The argument <tracerotate> is an integer from -2047 to +2047. The median value (0) represents a trace rotation angle of approximately 0 degrees. Each extreme value rotates the trace by about 15 degrees.

Syntax	DISPlay:TRACEROTate <tracerotate> DISPlay[:TRACEROTate]?
Arguments	<tracerotate>
Examples	disp:tracerot -100
Returns	display:tracerot? :DISPLAY:TRACEROTATE -100

DISPlay:SCALEillum <scale>

Adjusts the brightness level of the permanent scale on the CRT. The brightest value for the argument <scale> is 0 and the lowest is -2047. The best value depends on the brightness of the environment.

Syntax	DISPlay:SCALEillum <scale> DISPlay[:SCALEillum]?
---------------	---

Arguments <scale>

Examples disp:scale -100

Returns display:scale?
:DISPLAY:SCALEILLUM -100

DISPlay:FOCUS:<line select mode> <range>

Adjusts the CRT focus for different Line Select modes. The <range> for all of the FOCUS settings is -2047 to +2047. Table C-8 describes the command options.

Use this command to set the focus for displays using Normal, H1 or H15 LINE SELECT modes.

Syntax DISPLAY:FOCUS:<line select mode> <range>
DISPLAY[:FOCUS | :FOCUS:<line select mode>]?

Arguments :<line select mode> <range>

Table C-8: DISPlay:FOCUS command options

:<line select mode>	Selects	<range>
NORMAL See the command LINES:MODE.	Line select off	-2047 to +2047.
H1	H1	-2047 to +2047.
H15	H15	-2047 to +2047.

Examples DISPLAY:FOCUS:H1 2047
disp:focus:norm 100

Returns display:focus?
:DISPLAY:FOCUS:NORMAL 100;H1 2047;H15 2047

Error Commands

The waveform monitor detects errors and records error messages in an error message buffer. To determine whether an error has been recorded, send the query ESR?. If an error has been detected, the waveform monitor will respond with a message similar to :ESR 32. To get more information about the error, send the query ALLEV?. The response to the ALLEV? query will be similar to one of the error message types described in Table C-9.

ESR?

This query determines if the waveform monitor has recorded any command errors. If ESR? returns an error, use the ALLEV? query to determine the type of error recorded. Table C-9 describes possible error messages displayed by the waveform monitor.

Syntax	ESR?
Arguments	None
Examples	esr?
Returns	esr? :ESR 32 See Table C-9 for a list of possible command error reports returned by the ALLEV? query.

ALLEV?

This query is used to determine the type of command error reported by the waveform monitor. Table C-9 describes a list of possible error messages returned by ALLEV?. To use ALLEV?, query using ESR? to determine whether the waveform monitor has recorded any command errors. If an error was detected, use ALLEV? to help you determine the possible cause of the error.

The error messages displayed consist of three parts:

- An ALLEV response number
- A description of the error type
- A record of the command string in which the error was detected

The description of the error type and the record of the command string are enclosed in quotes. Multiple error messages are separated by a comma and an ALLEV response number.

Syntax ALLEV?

Arguments None

Table C-9: Typical ALLEV? responses to detected system errors.

ALLEV? report	Remarks
:ALLEV 0,"No events to report – queue empty"	No errors to report in the error message buffer.
:ALLEV 100,"Command error; command not allowed – vc: difference 1000"	This error message is typical of invalid commands or arguments; for instance, a misspelled or disallowed command.
:ALLEV 102,"Syntax error; invalid character data – arrow:limit:ntsc ire_133\0A"	This error message is typical of invalid arguments.
:ALLEV 103,"Invalid separator; illegal use of alias – disp:pixb 298990-909009\0A"	This error message is typical of invalid characters in the argument of a command.
:ALLEV 104,"Data type error; invalid character data – n:ltng:var:vert:value ON\0A"	This message is typical of invalid data types in the argument of a command; for instance, ASCII characters where an integer value is expected.
:ALLEV 113,"Undefined header; unrecognized command – gain:vec:var:horz:"	This message is typical of incorrect command strings; for instance commands sent without an argument.

Examples gain:ltng:var:vert:value ON (this is an invalid command)
 esr?
 :ESR 32

Returns allev?
 :ALLEV 104,"Data type error; invalid character data–n:var:vert:value ON\0A"
 See Table C-9 for additional examples.

Eye Pattern Commands

The commands in this section allow you to select either the Eye or EQEye displays and to toggle between the Overlay and 10 Eye modes. Use the command `DISPlay:SINGLE:EYe` to enable the Eye display.

EYe:DISPlay < FLAT | EQEYE> (WFM 601M Only)

Selects either the Flat (or raw) digital data stream or an Equalized data stream for the Eye display. The Flat mode corresponds to the EYE bezel button selection in the Eye display mode. The EQEYE mode compensates for cable loss in a long cable by applying receiver equalization to the signal.

Syntax EYe:DISPlay <FLAT | EQEYE>
EYe[:DISPlay]?

Arguments <FLAT | EQEYE>

Examples ey:disp eqeye

Returns eye:disp?
:EYE:DISPLAY EQEYE

EYe:MODE <OVERLAY | EYE10> (WFM 601E and WFM 601M Only)

Selects the trigger mode for the Eye display. OVERLAY displays three eyes and EYE10 displays 10 eyes.

Syntax EYe:MODE <OVERLAY | EYE10>
EYe[:MODE]?

Arguments <OVERLAY | EYE10>

Examples eye:mode eye10

Returns eye:mode?
:EYE:MODE EYE10

EYe:CLoCkhpF <E10HZ | E100HZ | E1000HZ>(WFM 601E and WFM 601M Only)

Selects between high-pass filters 10, 100, or 1000 Hz to suppress low-frequency jitter while in the Eye display mode.

Syntax EYe:CLoCkhpF <E10HZ | E100HZ | E1000HZ>
EYe[:CLoCkhpF]?

Arguments <E10HZ | E100HZ | E1000HZ>

Examples eye:clo e1000hz

Returns eye?
:EYE:DISPLAY EQEYE;MODE EYE10;CLOCKHPF E1000HZ (WFM 601M)
:EYE:MODE EYE10;CLOCKHPF E1000HZ (WFM 601E)

Gain Commands

The commands in this section allow you to select fixed gain levels or set variable gain levels for the Waveform, Vector, and Lightning displays.

GAIN:AUDIO <DBU0 | DBU4 | DBU8 | DBU12> (WFM 601A Only)

Sets the gain level of the analog audio input to the desired level and scales the electronic graticule accordingly.

Syntax GAIN:AUDIO <DBU0 | DBU4 | DBU8 | DBU12>
GAIN[:AUDIO]?

Arguments <DBU0 | DBU4 | DBU8 | DBU12>

Examples gain:audio dbu0

Returns gain:audio?
:GAIN:AUDIO 0

GAIN:W_V_STATE <x1 | x5 | x10>

Sets the fixed vertical gain of the Waveform display to X1, X5 or X10. Gain is selectable in the GAIN menu.

Syntax GAIN:W_V_STATE <x1 | x5 | x10>
GAIN[:W_V_STATE]?

Arguments <x1 | x5 | x10>

Examples gain:w_v_state x5

Returns gain:w_v_state?
:GAIN:W_V_STATE X5

GAIN:<WFM | VEC>:VAR:STATE <ON | OFF>

Sets variable vertical gain ON or OFF for the Waveform or the Vector displays. Variable gain is selectable in the GAIN menu.

Syntax GAIN:<WFM | VEC>:VAR:STATE <ON | OFF>
GAIN[:<WFM | VEC>:VAR:STATE]?

Arguments <WFM | VEC> and <ON | OFF>

Examples gain:wfm:var:state on

Returns gain:wfm:var:state?
:GAIN:WFM:VARIABLE:STATE ON

GAIN:<WFM | VEC>:VAR:VALUE <gain>

Sets the value of variable <gain> for the Waveform or Vector display to an integer value. The minimum value of <gain> is 200 and the maximum value is 3000.

Syntax GAIN:<WFM | VEC>:VAR:VALUE <gain>
GAIN:<WFM | VEC>:VAR:VALUE?

Arguments <WFM | VEC> and <gain>

Examples gain:vec:var:value 950

Returns gain:vec:var?
:GAIN:VECTOR:VARIABLE:STATE ON;VALUE 950

GAIN:LTNG:VAR:<VERT | HORZ>:STATE <ON | OFF>

Sets the variable vertical or horizontal gain ON or OFF for the Lightning display.

Syntax	GAIN:LTNG:VAR:<VERT HORZ>:STATE <ON OFF> GAIN:LTNG:VAR:<VERT HORZ>:STATE?
Arguments	<VERT HORZ> and <ON OFF>
Examples	gain:ltng:var:horz:state on
Returns	gain:ltng:var:horz:state? :GAIN:LTNG:VAR:HORIZ:STATE ON gain:ltng:var:horz? :GAIN:LTNG:VAR:HORIZ:STATE ON;VALUE 750

GAIN:LTNG:VAR:<VERT | HORZ>:VALUE <gain>

Sets the value of the variable vertical or horizontal gain for the Lightning display to an integer value between 200 (minimum) and 3000 (maximum).

Syntax	GAIN:LTNG:VAR:<VERT HORZ>:VALUE <gain> GAIN:LTNG:VAR:<VERT HORZ>:VALUE?
Arguments	<VERT HORZ> and <gain>
Examples	gain:ltng:var:vert:state on gain:ltng:var:vert:value 2000
Returns	gain:ltng:var:vert? :GAIN:LTNG:VAR:VERT: STATE ON;VALUE 2000

Input Commands

The commands in this section allow you to make the following changes to the waveform monitor:

- Select an input signal source
- Select which channel or channels to display
- Set the offset level for the Pb and Pr channels of the input signal

INput:SOUrce <SERIALA | SERIALB>

Selects the signal for display from the A or B rear-panel, loop-through inputs.

Syntax INput:SOUrce <SERIALA | SERIALB>
INput[:SOUrce]?

Arguments <SERIALA | SERIALB>

Examples in:sou seriala

Returns input:sou?
:INPUT:SOURCE SERIALA

INput:CHANnel <CH1 | CH2 | CH3>

Selects the component YPbPr or RGB channel to display in Waveform and Parade displays. The channel mapping is CH1 (Y/R), CH2 (Pb/G), CH3 (Pr/B) and any combination of the three channels can be displayed at one time by separating the channel options with commas.

Syntax	INput:CHANnel <CH1 CH2 CH3> INput[:CHANnel]?
Arguments	<CH1 CH2 CH3>
Examples	input:chan ch1,ch2
Returns	in:chan? :INPUT:CHANNEL CH1,CH2

INput:PBPROFFSet <MV_0 | MV_350>

Sets the offset for the Pb and Pr channels to either 0 mv or 350 mv.

Syntax	INput:PBPROFFSet <MV_0 MV_350> INput[:PBPROFFSet]?
Arguments	<MV_0 MV_350>
Examples	input:pbproffset mv_0
Returns	in? :INPUT:SOURCE SERIALA; CHANNEL CH1,CH2; PBPROFFSET MV_0

Jitter Measurement Commands

The commands in this section allow you to change parameters for the Jitter measurement display.

JITter:HPFILter <J10HZ | J1000HZ | J10KHZ | J100KHZ> (WFM 601M Only)

Selects the high-pass filter frequency for the Jitter measurement display. This setting corresponds to the Jitter HPF selection in the Config Jitter menu.

Syntax JITter:HPFILter <J10HZ | J1000HZ | J10KHZ | J100KHZ>
 JITter[:HPFILter]?

Arguments <J10HZ | J1000HZ | J10KHZ | J100KHZ>

Examples jit:hpfilter j1000hz
 jit:hpfil j10khz

Returns jit?
 :JITTER:HPFILTER J10KHZ;UNITS UI;ALIGNMENT 0.11 UI;TIMING 0.10
 UI

JITter:UNITS <SEC | UI | OFF> (WFM 601M Only)

Selects the units for the readout of jitter magnitude.

Syntax JITter:UNITS <SEC | UI | OFF>
 JITter[:UNITS]?

Arguments <SEC | UI | OFF>

Examples jit:units OFF

Returns jit:units?
 :JITTER:UNITS OFF

JITter:<ALIGNMENT | TIMING >? (WFM 601M Only)

Independently queries the magnitude of the jitter components. The **TIMING** measurement is the raw jitter and the **ALIGNMENT** is the jitter remaining after the high-pass filter (**JIT:HPFIL**). Use the command **JIT:UNITS** to pick the units of measure.

Syntax **JITter:<ALIGNMENT | TIMING >?**

Arguments **<ALIGNMENT | TIMING >**

Examples **jit:timing?**

Returns **jit:timing?**
 :JITTER:TIMING 0.10 UI

Line Select Commands

The commands in this section allow you to select the part of the video signal you wish to display and measure. Use the command MENU LINESelect (page C-50) to enable the Line Select functions.

LINESelect:<command> <options>

Table C-10 describes the LINESelect: commands and the argument options associated with each command. These commands correspond to the selections available when you press the LINE SELECT button.

Syntax LINESelect:<command> <options>
LINESelect[:<command>]?

Arguments :<command> <options>

Table C-10: LINESelect: commands and options

:<command>	<options>	Remarks
MODE	<ON OFF>	Selects whether the Line Select mode is ON or OFF.
FMODE	<ALL TWO>	Selects the mode that displays one line out of field 1 or field 2 or the same line in both fields.
FIELD	<F1 F2>	Selects from which field the Line Select sample is chosen. Select the line with the command LINES:NUMBER and the sample with LINES:SMPL.
DISP	<H1 H15 SAMPLE>	Selects the Line Select mode from single line (H1) or a range of 15 lines or a single sample within a line.
NUMBER	<line number>	Selects a particular horizontal line for Line Select. Select the field using the command LINES:FIELD and the sample using LINES:SMPL.
SMPL	<sample>	For the WFM 601M, selects a particular sample on a horizontal line for Line Select. Select the line with the command LINES:NUMBER and the field with LINES:FIELD.

Examples lines:mode on

Returns lines?
:LINESELECT:MODE ON;NUMBER 573;SMPL 741;FIELD F2;FMODE
TWO;DISPLAY SAMPLE

Position Commands

The commands in this section allow you to position displays vertically and horizontally on the graticule.

POSITION:VERTical:<display mode> <range>
POSITION:HORZ:<display mode> <range>

The POSition commands correspond to the bezel knobs that position the display vertically and horizontally. POSition:VERTical commands and options are listed in Table C–11. Table C–12 lists the POSition:HORZ (horizontal) commands and options.

Acceptable values for the argument <range> for both the vertical and horizontal positioning commands are from –500 to 500. When queried, vertical = 0 and horizontal = 0 indicates that the display is centered.

NOTE. For firmware versions V2.1 and below, to position the Lightning display using the remote commands, you must first put the waveform monitor into the Lightning display mode using the DISPlay:SINGLE VECtor (page C–25) and VECtor:GRATicule LTNG (page C–11) commands. Then use the VECtor display vertical and horizontal positioning commands listed in Tables C–11 and C–12. With V2.2 and above, positioning commands are effective without first selecting the Lightning display.

Syntax POSITION:<VERTical | HORZ>:<display mode> <range>
 POSITION[:<VERTical | HORZ> |
 :<VERTical | HORZ>:<display mode>]?

Arguments <display mode> <range>

Table C-11: POSition:VERTical commands and options

<display mode>	<range>	Remarks
WFM EYe BOWtie	-8188 to +8188	Positions the named display vertically.
PIX	-3120 to +966	Positions the Picture display vertically.
VECtor	-500 to +500	Positions the Vector display vertically.
LTNG	-500 to +500	Positions the Lightning display vertically.
ARROWhead	-2047 to +2047	Positions the Arrowhead Gamut display vertically.
DIAmond	-2047 to +2047	Positions the Diamond Gamut display vertically.
AUDIO (WFM 601A only)	-250 to +250	Positions the Audio display vertically.

Table C-12: POSition:HORZ commands and options

<display mode>	<range>	Remarks
WFM EYe BOWtie	-12282 to +12282	Positions the named display horizontally.
PIX	-2700 to +2700	Positions the Picture display horizontally.
VECtor	-500 to + 500	Positions the Vector display horizontally.
LTNG	-500 to +500	Positions the Lightning display horizontally.
ARROWhead	-2047 to +2047	Positions the Arrowhead Gamut display horizontally.
DIAmond	-2047 to +2047	Positions the Diamond Gamut display horizontally.
AUDIO (WFM 601A only)	-330 to +330	Positions the Audio display horizontally.

Examples pos:vertical:EYe 100

Returns pos:horz:eye?
 :POSITION:HORIZONTAL:EYE 0
 pos:vert:ey?
 :POSITION:VERTICAL:EYE 100

Preset Commands

The commands in this section allow you to select, store, and name parameter presets for the waveform monitor. Use the command UIMENU:PREset (page C-15) to enable the preset functions.

PREset:REcall <PRESETn | FACTORY >

Recalls the Preset stored in the named location. The preset function allows you to store up to ten front panel setups: Nine user defined presets and one factory preset. The factory preset is programmed to assist in calibrating the instrument.

The letter *n* in the argument <PRESETn> represents a number between 1 and 9.

Syntax PREset:REcall <PRESETn | FACTORY >

Arguments <PRESETn | FACTORY >

Examples preset:rec factory

Returns None

PREset:STORE <PRESETn>

Deletes the currently stored setting in the named memory location and replaces it with the current front panel settings. The letter *n* in the argument <PRESETn> represents a number between 1 and 9. (The waveform monitor can store 9 presets in addition to the FACTORY preset.)

Syntax PREset:STORE <PRESETn>

Arguments <PRESETn>

Examples preset:store preset1

Returns None

PREset:NAMES:<PRESETn> “any string”

Sets the name of the specified Preset. The name is limited to ten alphanumeric characters.

You can use the 25 pin REMOTE connector on the rear panel to save or recall Presets. The appropriate pin is grounded to select the front panel setup stored in that preset location. Grounding pin 25 with any one of the other preset pins stores the current front panel setup into that selected PRESET location. Refer to *Appendix B* for more information on using the REMOTE connector.

Syntax	PREset:NAMES:<PRESETn> “any string”
Arguments	:<PRESETn> “any string”
Examples	preset:names:preset5 “jit-meas” preset:names:preset1 “clock-meas”
Returns	None

Sweep Commands

The commands in this section allow you to manipulate the sweep characteristics of the waveform monitor.

SWEEP:TIMING <ONEL | TWOL | ONEF | TWOF>

Sets the sweep rate to one line (5 $\mu\text{sec}/\text{div}$), two line (10 $\mu\text{sec}/\text{div}$), one field, or two fields for displays other than the Parade and Eye displays. This command is equivalent to pressing the LINE/FIELD button on the Front Panel which has four states: ONELINE, TWOLINE, ONEFIELD, and TWOFIELD. One and two field sweep modes do not display a time/div readout.

To set the sweep rate for the Eye display and the Parade display when you are displaying multiple channels, see *SWEEP:TIMING <ONEL | ONEF>*.

Syntax SWEEP:TIMING <ONEL | TWOL | ONEF | TWOF>
SWEEP[:TIMING]?

Arguments <ONEL | TWOL | ONEF | TWOF>

Examples sweep:timing twol

Returns sweep:timing?
:SWEEP:TIMING TWOLINE

SWEEP:TIMING <ONEL | ONEF>

When you display more than one channel at a time in the Parade display, the SWEEP:TIMING command toggles between one line (ONEL) and one field (ONEF). In the Eye mode, the <ONEL | ONEF> argument allows you to toggle between a 1 and 3 ns/div line sweep rate and a field rate sweep.

To set the sweep rate for displays other than the Eye or multiple channel Parade displays see *SWEEP:TIMING <ONEL | TWOL | ONEF | TWOF>*.

Syntax	SWEEP:TIMING <ONEL ONEF> SWEEP[:TIMING]?
Arguments	<ONEL ONEF>
Examples	sweep:timing onef
Returns	sweep:timing? :SWEEP:TIMING ONEFIELD

SWEEP:MAG <OFF | ON>

Sets horizontal magnification ON or OFF.

Syntax	SWEEP:MAG <ON OFF> SWEEP[:MAG]?
Arguments	<ON OFF>
Examples	sweep:mag off
Returns	sweep? :SWEEP:TIMING ONEFIELD; MAGNIFY OFF

System Commands

Using the commands in this section you can make the following changes to the waveform monitor:

- Select menus needed to change various parameters of the waveform monitor
- Select an appropriate filter for the Waveform and Parade displays
- Enable and disable the AFC and ECHO functions, the readout alignment markers, and the internal calibration signal
- Access the serial number for the waveform monitor

MENU <FILTer | CURsor | LINESelect | CONFIG | GAIN | CRT | CLear | SERial>

Displays the named menu or clears the displayed menus. In the WFM and PARade displays, MENU:FILter displays the filters menu. In the Eye display, it indicates the filter in use at the top right corner of the screen.

Syntax MENU <FILTer | CURsor | LINESelect | CONFIG |
GAIN | CRT | CLear | SERial>
MENU?

Arguments <FILTer | CURsor | LINESelect | CONFIG | GAIN | CRT | CLear | SERial>

Examples menu lines
menu config
menu ser
menu cl

Returns menu?
:MENU CLEAR

FILTer <FLAT | DIFF | LP>

Selects a filter setting for the Waveform and Parade displays. Table C–13 describes the options for this command.

Syntax FILTer <FLAT | DIFF | LP>
FILTer?

Arguments <FLAT | DIFF | LP>

Table C–13: FILTer command options

Arguments	Remarks
FLAT	Selects a flat filter (all pass) for the Waveform and Parade displays.
DIFF	Selects a differentiated step filter for the Waveform and Parade displays.
LP	Selects a 1 MHz low-pass filter for the Waveform and Parade displays.

Examples filt flat

Returns filt?
:FILTER FLAT

AFC <ON | OFF>

Sets the Automatic Frequency Control Clock ON or OFF. When AFC is OFF the synchronization is DIRECT and when ON synchronization is from the AFC clock. AFC should be on except when large, low-frequency jitter is present in your system.

Syntax AFC <ON | OFF>
AFC?

Arguments <ON | OFF>

Examples afc on

Returns afc?
 :AFC ON

PORT:ECHO <ON | OFF>

Enables the echo of remote commands to the controlling device through the remote interface port. Echo should be on when using a monitor program and off when using a test program to send commands and receive data.

Syntax PORT:ECHO <ON | OFF>
 PORT[:ECHO]?

Arguments <ON | OFF>

Examples PORT:echo OFF

Returns port:echo?
 :PORT:ECHO OFF

ROTEST <ON | OFF>

Sets the Readout alignment markers ON or OFF. When set to On, four cross-shaped markers appear on the display. Use the Rotate bezel knob to adjust the display to match the horizontal and vertical graticule lines.

Syntax ROTEST <ON | OFF>
 ROTEST?

Arguments <ON | OFF>

Examples rotest off
 rotest on

Returns rotest?
 :ROTEST ON

SNID?

Returns the waveform monitor serial number.

Syntax	SNID?
Arguments	None
Examples	snid?
Returns	snid? :SNID B0123456

CALSignal:ENable <OFF | ON>

In Waveform display, turns ON/OFF the internal calibrator signal.

Syntax	CALSignal:ENable <OFF ON> CALSignal[:ENable]?
Arguments	<OFF ON>
Examples	cals:en OFF
Returns	cals? :CAL SIGNAL:ENABLE OFF

Remote Command Processing Code

The following code ensures that the waveform monitor does not drop any characters during remote command operations. This procedure expects a character string to send and places to put two types of responses: expected and unexpected.

```
/*
 * wfmt0601.c
 *
 * This module contains the processing functions required for a DOS or
 * Windows based PC to communicate effectively with the WFM601x family of
 * instruments. This code provides an example of the message buffering
 * required due to the lack of a hardware UART.
 *
 * This module uses a DOS communications code library included as a part
 * of the book "C Asynch Manager" copyright 1991 Blaise Computing Inc,
 * 819 Bancroft Way, Berkeley, CA 94701. The library is freely
 * redistributable as part of the product when you purchase the book.
 * Aside from purchasing its products, Tektronix has no business
 * relationship with Blaise, and under no circumstances warrants this
 * software for use to any particular purpose. Use this code at your own risk.
 */

#include "asynch_1.h"
#include <ctype.h>

/*
 * ASYNC library constants
 */
#define IO_BUFSIZ          2300
#define OKAY               0x600b

/* Number of connection attempts to make to the instrument */
#define NUMBER_OF_RETRIES 2

/*
 * Blaise Computing error code definitions (not a complete list):
 *
 * #define A_OK          0 // Operation successful
 * #define INV_PORT     1 // Invalid or uninitialized port
 * #define NO_PORT_FOUND 6 // Port not found at address
 * #define OUT_Q_FULL   7 // Output queue is filled
 * #define IN_Q_EMPTY   10 // Input queue is empty
 * #define TIMEOUT      12 // Timeout waiting for event
 * #define CANCEL       13 // Wait event cancelled by user
 */
```

```

        /*
        * Module WARNINGS (these warnings indicate bad communications or
        * invalid requests to the instrument)
        */
#define W_INVALID_RESP -1      /* Invalid response from instrument */
#define W_UNEXPEC_RESP -2     /* Unexpected response from instrument */

        /* Local communications port */
static int      comPort;

/*
 * init601Port - Initialize the port to communicate with the WFM601x
 *
 * This procedure connects the program to a COM port, attempts to open it,
 * and initialize communications with the instrument.  It returns either
 * A_OK (0), or an error code value indicating the problem.
 */
int
init601Port
(
    int      desiredComPort /* The desired COM port--from 1 to 4 */
)
{
    static unsigned char  ioBuf[IO_BUFSIZ]; /* Buf used by IO lib */
    int                  lStat, mStat;     /* Required status */

    register int          tryCounter;      /* Count tries */
    register int          errCode;        /* Keep error values */

        /* Check arguments for sanity */
if ( desiredComPort < 1 || desiredComPort > 4 )
    return INV_PORT;

        /* Set the desired communications port */
comPort = desiredComPort;

        /* Repeatedly attempt to initialize and open serial port */
for (tryCounter = 0; tryCounter < NUMBER_OF_RETIRES; tryCounter++)
    {
        /*
        * Initialize port protocol:
        * port #, 9600 Baud, no parity, no stop bits, 8 bit data
        */
errCode = init_a1(comPort, 7, 0, 0, 3, &lStat, &mStat);

        /*
        * If port initialized without error, open port and return
        */
if (errCode == OKAY)
    {
errCode = open_a1(comPort,
                sizeof(ioBuf) / 2, sizeof(ioBuf) / 2, 0, 0, ioBuf);
    }
    }
}

```

```

        if ( errCode == A_OK )
        {
            /* Set remote XON/XOFF flow control */
            (void) setop_a1(comPort, 6, 1);
            return A_OK;
        }

        break;
    }

    /*
     * Open and close port to reset it, and try to initialize
     * it again.
     */
    (void)open_a1(comPort, sizeof(ioBuf)/2, sizeof(ioBuf)/2, 0, 0, ioBuf);
    close_a1 (comPort);
}

/*
 * If we can't at least get an OK, the port is either
 * missing or busy.
 */
if ( tryCounter == NUMBER_OF_RETIRES )
    comPort = NO_PORT_FOUND;

    /* On error, unset the comPort and return */
comPort = 0;
return errCode;
}

/*
 * sendToWfm601 - Send data to an instrument from the WFM601x family
 *
 * This is the central procedure in this module. It sends "portMsg"-a
 * newline terminated string-to the instrument. If the message is a query,
 * this procedure waits for the instrument to respond and places that response
 * in "expectedResp". If the instrument returns any data while the message is
 * being sent, this procedure stores that data in "unexpectedResp" and returns
 * W_UNEXPEC_RESP. Finally, a cancel callback is accepted to allow the user
 * to decide when to stop waiting; cancelFunc is periodically called, and if
 * it returns a non-zero value, the procedure immediately terminates (pass
 * NULL if you don't want to use this feature).
 *
 * The response buffers should be at least 1024 chars in length, which is
 * the maximum length of an instrument response.
 */
int
sendToWfm601
(
    char *portMsg,          /* The newline terminated send message */
    char *expectedResp,    /* Buffer for expected responses */
    char *unexpectedResp,  /* Buffer for unexpected responses */
    int (*cancelFunc)(void) /* User cancel routine to stop waiting */
)
{

```

```
register char  sendChar;      /* Char to send to the instrument */
char          recvChar;      /* Char received from the instrument */
unsigned int  portStatus;    /* Status of the serial port */

int           isQuery = 0;    /* Set if portMsg is a query */
char         *baseUnexp;     /* The base unexpected response */

register int   libError;      /* Error code returned from library */
int           iq_size;       /* Unused return arg required by lib */
int           iSendAttempt;  /* Counter to halt pgm after x retries */

/* Return invalid port when port has not been initialized */
if ( comPort == 0 )
    return INV_PORT;

/* Set the base unexpected response pointer */
baseUnexp = unexpectedResp;

/* Initialize the send attempt counter */
iSendAttempt = 0;

/* Loop until we reach the end of string */
while ((sendChar = *portMsg) != '\0')
{
    /* Force character to be lower case */
    if ( isupper(sendChar) )
        sendChar = tolower(sendChar);

    /* Send the current character to the instrument */
    if ((libError = wrtch_al (comPort, sendChar)) != A_OK)
        return libError;

    /* Wait (up to 10 seconds) for char to be sent */
    libError = drain_al(2, 10 * 19, 0);

    /* Complain if char was not sent (bad cable?) */
    if (libError != A_OK && libError != TIMEOUT)
        return libError;

    /* Record whether this is a query command */
    if ( sendChar == '?' )
        isQuery = 1;

    /* Loop until all characters are sent */
    for(;;)
    {
        /* Wait up to 30 seconds for instrument response */
        iwait_al (comPort, 30 * 19L, &portStatus, cancelFunc);

        /* Get the instrument echo character */
        libError = rdch_al(comPort, &recvChar, &iq_size, &portStatus);

        /* On any error (bad cable) return error */
        if (libError != A_OK)
        {
```

```

/* If no character is present (i.e., no echo response)
 * then resend the dropped character. But if
 * number of retries has been exceeded, then bail out
 */
if (libError == IN_Q_EMPTY)
{
if (iSendAttempt++ > NUMBER_OF_RETRIES )
{
strcpy( expectedResp, "NADA");
printf("\nNo Response");
getch();
return libError;
}
break;
}
else
return libError;
}

/* Everything is Fine */
if ( sendChar == recvChar )
{
/* Advance the port message string */
portMsg++;

/* now that we have a successful echo, reset the 'send attempt'
 * counter
 */
iSendAttempt = 0;

if ( recvChar == '\n' )
{
/* If this was a '\n', expect a trailing '\r' */
if ((libError = iwait_al(comPort, 20 * 19L,
&portStatus, cancelFunc)) != A_OK)
return libError;

/* Get the instrument echo character */
if ((libError = rdch_al(comPort, &recvChar,
&iq_size, &portStatus)) != A_OK)
return libError;

/* Check if we failed to get a trailing return */
if ( recvChar != '\r' )
return W_INVALID_RESP;
}

/* Break to send next character */
break;
}

/*
 * Instrument returned an unrelated character. Record it.
 * Continue to resend this character.
 */
*unexpectedResp++ = recvChar;

```

```
/* Break out of this loop and halt the program if
 * the max number of retries has been exceeded.
 */
if (iSendAttempt++ > NUMBER_OF_RETRIES)
{
    strcpy(expectedResp, "NADA");
    printf("\nUnrelated character returned");
    getch();
    return libError;
} /* end for(;;) character sending loop */
} /* end while() port message sending loop */

/*
 * If this is a query, read the next line.
 * Wait forever until we get it.
 */
if ( isQuery )
{
    for (;;)
    {
        /* Wait up to 20 seconds for instrument response */
        if ( (libError = iwait_al (comPort, 20 * 19L,
                                &portStatus, cancelFunc)) != A_OK)
            return libError;

        /* Get the instrument echo character */
        if ( (libError =
            rdch_al(comPort, expectedResp, &iq_size, &portStatus)) != A_OK)
            return libError;

        /* Advance if character read wasn't a return */
        if ( *expectedResp != '\n' )
            expectedResp++;

        else
        {
            /* It was... expect a trailing '\r' */
            if ((libError =iwait_al(comPort, 20 * 19L,
                                &portStatus, cancelFunc)) != A_OK)
                return libError;

            /* Get the instrument echo character */
            if ((libError =
                rdch_al(comPort, &recvChar, &iq_size, &portStatus)) != A_OK)
                return libError;

            /* Check if we failed to get a trailing return */
            if ( recvChar != '\r' )
                return W_INVALID_RESP;

            break;
        }
    }
}
```



```
        /* Terminate the string of chars received above          */
*expectedResp = '\0';

        /* Return an unexpected warning if we got one from the instrument */
if ( unexpectedResp != baseUnexp )
    return W_UNEXPEC_RESP;

return 0;
}
```

Appendix D: User Service

This section describes preventive maintenance for the waveform monitor and how to replace graticule light bulbs. If the waveform monitor does not function properly, send it to a qualified service personnel or contact Tektronix for service.

Cleaning or Replacing the Fan Filter

To ensure adequate air flow, clean or replace the rear-panel fan filter regularly. The interval between filter cleaning or replacement is determined by the operating environment. In a dusty environment, check the filter monthly. The Accessories kit shipped with your waveform monitor contain several replacement filters.

To clean or replace the filter, follow these steps:

1. Turn off power to the waveform monitor.
2. Carefully pull the fan cover housing off the fan. No screws attach the cover to the fan.
3. Remove the filter from the fan cover.
4. Wash the filter in a mild detergent solution, rinse thoroughly and dry. Place the clean, dry filter or a new filter in the fan cover.
5. Replace the cover over the fan.

Fuse Replacement

The line fuse for this instrument is located inside the cabinet, under a protective shield. Do not attempt to replace this fuse. Contact a qualified service technician for assistance.

Graticule Light Replacement

The graticule is illuminated by small light bulbs located under the bezel that surrounds the CRT. You or a service person can replace these bulbs if they burn out. The Accessories kit shipped with your waveform monitor contain several replacement bulbs. Additional bulbs can be purchased from Tektronix or from local electronics distribution sources.

Required Tools This procedure requires the following tools:

- 1/16 inch Allen wrench
- Small, straight-blade screwdriver
- Tweezers with curved or serrated tips

Procedure Follow these steps to replace a graticule light bulb:

1. Turn off the Power switch and disconnect the AC line cord.
2. Using the Allen wrench, loosen the set screws in the five knobs below the CRT; then remove the knobs.
3. Insert a small, straight-blade screwdriver into the recessed area on the right or left side of the panel. Pry gently until the panel snaps out of the front-panel frame. See Figure D-1 for panel and recess locations.

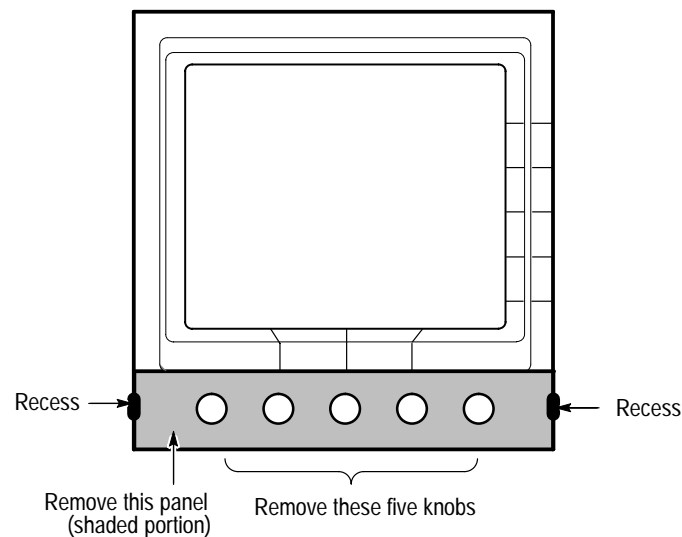

Figure D-1: Graticule light bulb replacement



CAUTION. *Needle-nosed pliers are not recommended in the following step, as they are more likely to break a bulb.*

4. To remove a bulb, position the tweezer tips on the thin, flat portion of the bulb (close to the plastic socket). Carefully pull the bulb straight out.
5. To install a new bulb, hold it with the tweezers on the flat portion, align the bulb leads with the socket, and push the bulb in until it snaps into place.
6. Place the panel below the CRT, and press on both the right and left sides of the panel until it snaps into place.
7. Replace the five knobs below the CRT and tighten the set screws.

Cleaning

Clean the dust from the outside of the waveform monitor with a soft, clean cloth or small brush. A brush is especially useful for removing dust from around the selector buttons, knobs, and connectors. Hardened dirt can be removed using a soft cloth, dampened with a mild detergent solution. Do not use abrasive cleaners.



CAUTION. *Do not allow water to get inside any enclosed assembly or component. Do not clean any plastic materials with benzene, toluene, xylene, acetone, or similar compounds, because they may damage the plastic.*

Clean the light filter and CRT face with a soft, lint-free cloth dampened in denatured alcohol. Do not use abrasive cleaners.

Interior cleaning and maintenance should be performed only by qualified service personnel. Instructions for interior maintenance are provided in the Service manual.

Replacing the CRT Filter

A smoke-gray filter covers and protects the face of the CRT. If the filter becomes damaged, replace it by following these steps:

1. Turn off the Power switch and disconnect the AC line cord.
2. Using the Allen wrench, loosen the set screws in the five knobs below the CRT; then remove the knobs.

3. Insert a small, straight-blade screwdriver into the recessed area on the right or left side of the panel. Pry gently until the panel snaps out of the front-panel frame. See D-1 for panel and recess location.
4. Remove the two Torx® screws that fasten the bezel to the waveform monitor.
5. Grasp the bottom of the bezel and pull out and upward to remove the bezel from the instrument. Two hinges at the top of the bezel hold it in place. Once the bezel is at a 45° angle with the front panel, they disengage. Remove the damaged filter out the back of the bezel piece.
6. Snap the new filter into place on the back side of the bezel. Position the ridged side of the filter towards the CRT.
7. Replace the bezel and bezel screws. Tighten the screws. Be careful not to overtighten them.
8. Place the panel below the CRT, and press on both the right and left sides of the panel until it snaps into place.
9. Replace the five knobs below the CRT and tighten the set screws.



Glossary

Glossary

Accuracy

The closeness of the indicated value to the true value.

Bandwidth

The range of frequencies over which signal amplitude remains constant (within some limit) as it is passed through a system.

Baseband

Refers to the composite video signal as it exists before modulating the picture carrier. Composite video distributed throughout a studio and used for recording is at baseband.

Bowtie Display

A display used to assess relative timing and gain through a three-channel component system.

Color Difference Signals

Signals used by color television systems to convey color information in such a way that the signals go to zero when there is no color in the picture. R–Y, B–Y, I, and Q are all color difference signals for the NTSC system; U and V are color difference signals for the PAL system. The component system color difference signals are Y, P_B, P_R as specified by SMPTE and CCIR standards.

Color Gamut

The area between minimum and maximum reproducible limits for elements of the color difference or RGB signals.

Component Video

Video which exists in the form of three separate signals, all of which are required in order to completely specify the color picture. For example, R, G, and B; or Y, R–Y, and B–Y.

Composite Video

A single video signal containing all of the necessary information to reproduce a color picture. Created by adding quadrature amplitude modulated R–Y and B–Y to the luminance signal for NTSC systems or U and V to the luminance signal for PAL systems.

CRC

Cyclic Redundancy Code. A series of transmitted bits used to enhance the error detection capabilities of a system.

dB (Decibel)

A logarithmic unit used to describe signal ratios. For voltages, $dB = 20 \text{ Log}_{10} (V_1/V_2)$.

Diamond Display

A simplified vector display for RGB signals that defines the valid gamut limits in the form of two diamonds.

Distortion

See harmonic distortion.

EDH

Error detection and handling. Supports the standard SMPTE RP-165, which proposes a technique for recognizing inaccuracies in the serial digital signal.

Frame

Contains all the information required for a complete picture. For interlaced scan systems, there are two fields in a frame.

Gamma

A measure that compares the contrast in the original and reproduced television picture. Since picture monitors have a nonlinear relationship between the input voltage and brightness, the signal must be correspondingly enhanced to nullify the nonlinear distortion. Gamma correction is always done at the source (camera) in television systems: the R, G, and B signals are converted to $R^{1/\gamma}$, $G^{1/\gamma}$, and $B^{1/\gamma}$. Values of about 2.2 are typically used for gamma.

Gamut

See Color Gamut.

GBR

See RGB.

Graticule

The scale which is used to quantify the displayed signal on a waveform monitor or vectorscope. Graticules may either be screened onto the faceplate of the CRT (internal graticule), or onto a piece of glass or plastic that fits in front of the CRT (external graticule). They can be electronically generated.

Harmonic Distortion

Signal distortion caused by non-linearities in a system. System non-linearities produce multiples of a single frequency signal applied to the the system. Harmonic distortion is evident when a pure sine wave applied to a system produces harmonic content at multiples of the sine wave frequency at the output.

Hue

The property of color that allows us to distinguish between colors such as red, yellow, purple, etc.

Lightning Display

A display, for use with SMPTE specified color difference signals (Y , P_B , P_R), that plots the two color difference signals against luminance to create a display similar in appearance to a lightning bolt.

Linear Distortion

Refers to distortions which are independent of signal amplitude.

Lissajous figure

An X–Y plot in which the signals applied to both axes are sinusoidal functions. For a stable display the signals must be harmonics. Lissajous figures are useful for determining phase and harmonic relationships.

LSB

Least Significant Bit. The lowest weighted bit or signal line.

Luminance

The signal (Y) which represents brightness or the amount of light in the picture. Luminance is the only signal required for black and white pictures. For color systems, it is obtained as a weighted sum ($Y = 0.3R + 0.59G + 0.11B$) of the R, G, and B signals.

MSB

Most Significant Bit. The highest weighted bit or signal line.

Nonlinear Distortion

Refers to distortions which are amplitude-dependent.

NTSC

National Television System Committee. The organization which developed the television standard currently in use in the United States, Canada, and Japan. Now generally used to refer to that standard.

PAL

Phase Alternate Line. Refers to one of the television systems used in Europe and many other parts of the world. The phase of one of the color difference signals alternates from line to line to help cancel out phase errors.

Pb

A color difference signal used in component video systems. It is derived by subtracting the B (blue) signal from Y.

Pr

A color difference signal used in component video systems. It is derived by subtracting the R (red) signal from Y.

Receiver Equalization

Refers to recovering the data signal after cable loss. The signal is boosted to its original standard amplitude.

RF

Radio Frequency. In television applications, RF generally refers to the television signal after the picture carrier modulation process.

RGB

Red, Green, and Blue. Also referred to as GBR in SMPTE specifications. The three primary colors used in color television's additive color reproduc-

tion system. These are the three color signals generated by the camera and used by the picture monitor to produce a picture.

R–Y

One of the color difference signals obtained by subtracting luminance (Y) from the red camera signal.

Saturation

The property of color which relates to the amount of white light in the color. Highly saturated colors are vivid, while less saturated colors have more white mixed in and, therefore, appear pastel. For example, red is highly saturated, while pink is the same hue, but less saturated.

In signal terms, saturation is determined by the ratio between luminance level and chrominance amplitude. It should be noted that a vectorscope does not display saturation; the length of the vectors represents chrominance amplitude. In order to verify that the saturation of the colors in a color bar signal is correct, you must check luminance amplitudes with a waveform monitor in addition to observing the vectors.

Termination

In order to accurately send a signal through a transmission line, there must be an impedance at the end which matches the impedance of the source and of the line itself. Amplitude errors and reflections will otherwise result. Video is a 75 Ω system, so a 75 Ω terminator must be put at the end of the signal path.

U

The B–Y signal after a weighting factor of 0.493 has been applied. The weighting is necessary to reduce peak modulation in the composite signal.

V

The R–Y signal after a weighting factor of 0.877 has been applied. The weighting is necessary to reduce peak modulation in the composite signal.

Vectorscope

A specialized oscilloscope which demodulates the video signal and presents a display of R–Y versus B–Y in NTSC systems (or V versus U in PAL systems). The angle and magnitude of the displayed vectors are respectively related to hue and saturation.

Vertical Interval

The synchronizing information that appears between fields and signals the picture monitor to return to the top of the screen to begin another vertical scan.

Waveform Monitor

A specialized oscilloscope that plots voltage versus time to evaluate television signals.

Y

See Luminance.



Index

Index

A

- Aberrations, serial channel measurements, 3–23
- Accessories, 1–2
 - optional accessories, 1–3
 - Options, 1–3
 - standard (included), 1–2
- Accuracy, *Glossary–1*
- Active PIC CRC Error, in Configure SER ALARM menu, 3–11
- AFC, synchronization selection, 3–11
- Air filter, part number, 1–2
- ALARM, 2–4
- Alarm
 - based on serial format checks, 3–44
 - Gamut alarm, 3–33
- ALARM DISP, in Configure GAMUT menu, 3–10
- Amplitude, serial channel measurements, 3–22
- Analog Audio, see Audio, 3–1
- ANC Checksum, Serial format checks, 3–49
- ANC Parity, Serial format checks, 3–48
- AP CRC, using to measure error rate, 3–51
- AP CRC ERR SEC, Serial format selection, 3–46
- Arrowhead Display
 - composite gamut, 3–31
 - NTSC and PAL graticules, 3–31
 - setting format, 3–32
- Audio
 - analog signals, 3–1
 - display, 3–1
 - gain, 3–4
 - graticule calibrations, 3–4
 - Lissajous patterns, 3–1
 - measuring phase error, 3–4
 - Serial format selection, 3–46
- Audio display, 1–26, 2–3
- Automatic, format checks, 3–44

B

- Bowtie Display, 3–5
 - relative gain check, 3–6
 - timing measurement, 3–6
- Buttons, functional overview, 2–2

C

- Cabinetizing, 1–8
- Cabinets, 1–5

- 1700F00, 1–3
- blank panel, 1–10
- Cable Length
 - measurement, 3–49
 - measurement for firmware V1.X, 3–47
- Cable Screen, 3–49
- CABLE TYPE
 - for firmware V1.X, 3–47
 - serial format selection, 3–50
- CAL SIG, configuration menu, 3–12
- Calibrate
 - CONFIG menu, 3–12
 - gain, 3–12
- Calibration, 3–7
 - horizontal gain, 3–7
 - vertical gain, 3–7
- Calibrator, calibration signal, 1–2
- Certifications and Compliances, A–11
- Changed Since Reset, Serial format selection, 3–46
- Check, after shipment, 1–15
- Cleaning, the instrument, D–3
- Cleaning Fan Filter, D–1
- CLEAR MENU, 2–5
- Clock BW, in Configure EYE PATTERN menu, 3–10
- Color Bars, in Configure WFM/VEC menu, 3–9
- Command set, C–1
- Component video, *Glossary–1*
- Composite, setting Gamut alarm, 3–33
- Composite gamut
 - checking, 3–32
 - Diamond Display, 3–31
- Composite video, *Glossary–1*
- CONFIG menu, map of functions, 3–8, 3–9
- Configuration menu
 - Calibrate CAL SIG, 3–12
 - Calibrate GAIN CAL, 3–12
- Configure menu
 - Calibrate description, 3–12
 - description, 3–8
 - Eye Pattern description, 3–10
 - Eye pattern filters, 3–19
 - Format description, 3–11
 - Gamut description, 3–10
 - Jitter description, 3–10
 - Jitter Display settings, 3–38
 - map of functions, 3–9
 - SER ARM description, 3–11
 - WFM/VEC description, 3–9
- Connector
 - compatibility, 1–14

- Remote, B-1
 - RS232, B-1
- Connectors, rear panel, 2-6
- Coprocessor code version, determining software version, 3-12
- CRC
 - use in AP CRC measurements, 3-51
 - use in EDH measurements, 3-50
- CRC value, in Serial format screen, 3-46
- Cross hair cursor, on picture monitor output, 3-39
- CRT
 - filter part number, 1-2
 - filter replacement, D-3
 - setting intensity, 3-12
- Cursor Menu, 3-13
- Cursors, 3-13
 - Both selection, 3-13
 - data cursor correlated, 3-39
 - on MON OUT video, 3-39
 - on picture monitor output, 3-39
 - timing, 3-13
 - timing Cursors with Magnification, 3-13
 - using in Waveform display, 3-58
 - using Markers, 3-13
 - using with Gain, 3-13
 - voltage, 3-13

D

- Data
 - jitter measurement with Eye Pattern, 3-27
 - mode in Digital List display, 3-14
 - mode in Digital Waveform display, 3-16
 - viewing with Digital List display, 3-14
 - viewing with Digital Waveform display, 3-16
- Data Cursor
 - correlation with Digital Waveform display, 3-16
 - on Digital Waveform display, 3-17
- Data format
 - for Digital List display, 3-15
 - for Digital Waveform display, 3-16
- Data Range, Serial format checks, 3-48
- Diamond Display
 - checking RGB Gamut, 3-30
 - construction of the diamond graticule, 3-29
 - RGB gamut, 3-29
- DIFF, Filter menu selection, 3-27
- Digital List, 3-14
 - Freeze/Update selection, 3-15
 - Line Select interaction, 3-15
 - picking the data format, 3-15
 - Video and Data modes, 3-14

- Digital Waveform, 3-16
 - in Functional Check, 1-24
 - output monitor signals, 3-17
 - picking the data format, 3-16
 - using Gain, 3-18
 - using Line Select, 3-18
 - Video and Data modes, 3-16
- Direct, synchronization selection, 3-11
- Display
 - Audio, 3-1
 - Bowtie, 3-5
 - Multiple, 3-41
 - Parade, 3-41
 - Serial format selection, 3-46
 - serial format selection, 3-50
 - setting intensity, 3-12
 - Vector modes, 3-53
 - Waveform, 3-58

E

- EAV-SAV, in Configure WFM/VEC menu, 3-9
- EDH, using to measure error rate, 3-50
- EDH DET, front panel indicator, 2-4
- Elapsed Time, Serial format selection, 3-46
- Electrical specifications, A-1
- Enclosure, cabinet selection, 1-5
- Environmental Characteristics, A-9
- EQ EYE, receiver equalization mode, 3-19
- Error rate
 - AP CRC measurements, 3-51-3-53
 - EDH measurements, 3-50-3-53
 - measurements, 3-50-3-53
- Errored seconds
 - full field, 3-46
 - Serial format screen, 3-45
- EXT REF input, 2-7
- External Reference Input, Loop-Through Inputs, 2-7
- Eye Display
 - in Functional Check, 1-20
 - reference discussion, 3-19
- EYE PATTERN, Configure menu, 3-10
- Eye Pattern
 - See also* Eye Display
 - 10 Eye trigger mode, 3-21
 - aberration measurement, 3-23
 - amplitude measurement, 3-22
 - Clock BW filter, 3-19
 - Clock BW filters, 3-19
 - Configure menu, 3-10
 - EQ EYE mode, 3-19
 - FLAT mode, 3-19

- jitter measurement, 3–26
- measurements, 3–22
- Overlay trigger mode, 3–20
- rise time actual, 3–25
- rise time measurement, 3–24
- Trigger Modes, 3–20
- vertical gain, 3–21
- word correlated behavior, 3–27

F

- F1 AP CRC Value, Serial format selection, 3–46
- F2 AP CRC Value, Serial format selection, 3–46
- Fan, filter part number, 1–2
- Fan filter, cleaning or replacing, D–1
- Features, product features, 1–1
- FF CRC ERR SEC, Serial format selection, 3–46
- Field
 - selecting, 3–39
 - selecting one or two for display, 3–52
- Field Length, Serial format checks, 3–48
- 15H Line Select mode, 3–39
- Filter
 - fan filter part number, 1–2
 - for Eye Pattern, 3–19
 - for Parade Display, 3–27
 - for Waveform Display, 3–27
 - high pass for Jitter Display, 3–38
- Filter Menu, 3–27
- Firmware, determining software version, 3–12
- 525/625 Lines, Serial format selection, 3–46
- FLAT, Filter menu selection, 3–27
- FLAT EYE, Eye Pattern mode, 3–19
- flesh tone indicator, 3–54
- FMT Error, in Configure SER ALARM menu, 3–11
- FORMAT, configuration menu, 3–11
- Format, serial status, 3–44
- Format Error, Serial format selection, 3–46
- Format Screen, 3–48
- Freeze/Update, for Digital List display, 3–15
- Front panel
 - ALARM indicator, 2–4
 - Clear Menu, 2–5
 - DISPLAY buttons, 2–2
 - EDH DET indicator, 2–4
 - LINE/FIELD, 2–4
 - MAG, 2–4
 - MENU, 2–4
 - overview of functions, 2–1
 - POWER, 2–5
 - REF, 2–4
 - saving settings, 3–43

- SERIAL, 2–4
- SWEEP, 2–4
 - using bezel buttons, 2–4
 - using bezel knobs, 2–4
- VIDEO IN, 2–4
- Front Panel Controls and Indicators, 2–1
- Full Field CRC Error, in Configure SER ALARM menu, 3–11
- Full field CRC errored seconds, 3–46
- Functional Check, 1–15–1–26
 - Audio display, 1–26
 - Digital Waveform, 1–24
 - Eye Display, 1–20
 - Gamut displays, 1–23
 - Jitter Display, 1–20
 - procedure, 1–17
 - required equipment, 1–15
 - Vector Display, 1–21
- Functional Overview, 2–1
 - ALARM, 2–4
 - Audio display, 2–3
 - CLEAR MENU, 2–5
 - DISPLAY buttons, 2–2
 - EDH DET, 2–4
 - Front Panel, 2–1
 - LINE/FIELD button, 2–4
 - MAG button, 2–4
 - MENU, 2–4
 - POWER, 2–5
 - REF, 2–4
 - SERIAL, 2–4
 - SWEEP buttons, 2–4
 - VIDEO IN button, 2–4
- Fuse
 - fuse part number, 1–2
 - replacing, D–1

G

- Gain
 - audio, 3–4
 - calibration, 3–12
 - for Eye Pattern, 3–21
 - menu, 3–28
 - relative gain check with Bowtie display, 3–6
 - using with Cursors, 3–13
 - using with Digital Waveform display, 3–18
 - Waveform display, 3–58
- GAIN CAL, configuration menu, 3–12
- GAMUT
 - configure menu, 3–10
 - in Configure GAMUT menu, 3–10

- Gamut Alarm, 3–33
- Gamut Check, in Configure GAMUT menu, 3–10
- Gamut display, 3–29
 - Arrowhead Display, 3–31
 - checking RGB gamut, 3–30
 - composite Arrowhead Display, 3–31
 - configure menu, 3–10
 - Diamond Display, 3–29
 - in Functional Check, 1–23
 - setting Gamut alarms, 3–33
- Glossary, Glossary–1
- Graticule
 - 2T Pulse to Bar measurement, 3–36
 - Arrowhead NTSC and PAL, 3–31
 - Audio display, 3–4
 - for Vector Display, 3–54
 - horizontal scale, 3–36
 - internal, 3–34
 - K-factor measurement, 3–35
 - K-factor setup for measurement, 3–35
 - light bulb part number, 1–2
 - Lightning Display, 3–56
 - line definition, 3–34
 - vertical scale, 3–34
 - waveform measurements, 3–34
- Graticule light bulbs, replacement procedure, D–2

H

- Hardware installation, 1–5–1–11
- Harmonic distortion, Glossary–2
- Horiz Pos, using with MAG function, 3–36
- Horizontal gain, calibration, 3–7
- Horizontal scale, waveform graticule, 3–36
- Hue measurement, with Vector Display, 3–53

I

- Incoming inspection procedure, 1–15
- Inputs
 - rear panel, 2–7
 - selecting SER A or B, 3–58
- Installation, 1–5–1–14
 - accessory drawer, 1–10
 - BNC connector compatibility, 1–14
 - cabinet selection, 1–5
 - connecting power, 1–11
 - hardware, 1–5
 - in a serial video system, 1–12
 - installing in a rack, 1–9
 - line termination, 1–13

- repackaging for shipment, 1–10
- Instrument specifications, A–1

J

- Jitter
 - configure menu, 3–10
 - definition, 3–26
 - demodulation, 3–38
 - serial channel measurements, 3–26
 - using Line Select to limit measurement, 3–38
 - viewing waveform, 3–37
- Jitter Display, 3–37
 - Configure menu, 3–38
 - configure menu, 3–10
 - in Functional Check, 1–20
- Jitter HPF, in Configure JITTER menu, 3–10
- JITTER OUT, signal origin, 3–37

K

- K-factor measurement
 - graticule illustration, 3–35
 - special graticule, 3–35
 - using Gain with, 3–35

L

- Light bulb part number, 1–2
- Lightning Display, 3–55, Glossary–2
 - creating from Pb, Pr, and Y, 3–55
 - interchannel timing measurement, 3–57
 - luminance gain measurement, 3–57
 - PbPr gain measurement, 3–57
- Limit Cursors, for Gamut alarm, 3–32
- Limit Format, in Configure GAMUT menu, 3–10
- Line
 - selecting individual, 3–39
 - selecting number of lines in sweep, 3–52
- Line Length, Serial format checks, 3–48
- Line Select, 3–39
 - data cursor correlation, 3–39
 - selecting fields, 3–39
 - use with Digital Waveform display, 3–18
- Line/Field, Sweep, 2–4
- Lissajous, patterns, 3–1–3–3
- List, Digital List display, 3–14
- Loop-through inputs, 2–7
- LPASS, Filter menu selection, 3–27
- Luminance, Glossary–3

M

MAG, using with Timing Cursors, 3–13
 Magnified, Sweep, 2–4
 Manual, Service part number, 1–3
 Manuals, related, xi
 Markers, using, 3–13
 Measurement
 amplitude with Vector Display, 3–54
 cable commands, C–3
 cable length, 3–49
 cable length for firmware V1.X, 3–47
 cable loss, 3–49
 calculating actual rise time, 3–25
 Cursor measurements, 3–13
 error rate using AP CRC, 3–51
 error rate using EDH, 3–50
 Eye Pattern aberrations, 3–23–3–29
 Eye Pattern amplitude, 3–22–3–29
 Eye Pattern jitter, 3–26
 Eye Pattern measurements, 3–22–3–29
 Eye Pattern rise time, 3–24–3–29
 graticule, 3–34
 interchannel timing with Lightning Display, 3–57
 Jitter Display, 3–37
 luminance gain with Lightning Display, 3–57
 observing word correlated behavior, 3–27
 PbPr gain with Lightning Display, 3–57
 phase error with Audio display, 3–4
 phase with Vector Display, 3–54
 serial data error rate, 3–50
 serial signal level for V1.X firmware, 3–47
 source signal level, 3–49
 vector timing with Vector Display, 3–55
 Measuring serial sources, 3–22–3–29
 Mechanical installation, 1–5
 MENU, buttons, 2–4
 Menu, 1–2
 CRT, 3–12
 Cursor, 3–13
 Filter, 3–27
 Gain, 3–28
 Line Select, 3–39
 Preset, 3–43
 use, 2–5
 with bezel buttons, 2–5
 with bezel knobs, 2–5
 Menus, Using the Menus, 2–5
 Missing Video, in Configure SER ALARM menu, 3–11
 Mode, in Configure EYE PATTERN menu, 3–10
 MON OUT
 configuring as GBR or YPbPr, 3–11
 Format Configure menu, 3–11

shifting with Line Select, 3–39

Multi-pin connectors, 2–7

Multiple Display, 3–41

N

Naming, Preset, 3–43

NTSC

 Arrowhead Gamut graticule, 3–31

 setting alarm cursor, 3–32

O

Optional Accessories, 1–3

Options, 1–3

Other ANC Data, Serial format selection, 3–46

Output, setting monitor out, 3–11

Outputs

 Jitter Out, 2–7

 MON OUT (Y/G - PB/B - PR/R), 2–7

 rear panel, 2–7

 Serial Out, 2–7

Overlay, Eye Pattern trigger mode, 3–20

P

Packaging, shipping carton, 1–10

PAL

 Arrowhead Gamut graticule, 3–31

 setting alarm cursor, 3–32

Parade Display, 3–41

 filter selection, 3–27

PbPr

 Gain measurement with Lightning Display, 3–57

 plotted against Luminance, 3–55

 Vector Display, 3–53

PBPR Offset, in Configure WFM/VEC menu, 3–9

Performance requirements, Specifications, A–1

Phase error, audio, 3–4

Physical Characteristics, A–9

Picture Display, 3–42

Power

 AC requirements, 1–11

 requirements, 2–6

POWER (Switch), 2–5

Power connector, 2–6

Power cord

 Option A1, 1–3

 Option A2, 1–3

 Option A3, 1–3

 Option A4, 1–3

- Option A5, 1–3
- options, 1–3
- Power, connecting, 1–11
- PR to Y Timing, 3–57
- Preset, renaming, 3–43
- Preset Menu, 3–43
 - Recall, 3–43
 - Recover, 3–43
 - Rename, 3–43
 - Return, 3–43
 - Store, 3–43
- Procedure, Functional Check, 1–17
- Product Description, 1–1

R

- Rack Adaptor, 1–9
- Readout
 - in Configure JITTER menu, 3–10
 - setting brightness, 3–12
- Rear panel
 - connectors, 2–6
 - Jitter Out, 2–7
 - loop-through inputs, 2–7
 - MON OUT (Y/G - PB/B - PR/R), 2–7
 - multi-pin connectors, 2–7
 - outputs, 2–7
 - power connector, 2–6
 - Remote, 2–7
 - RS-232 connector, 2–7
 - Serial Out, 2–7
- Recall, Preset function, 3–43
- Recalling, Preset front panel settings, 3–43
- Recover, Preset function, 3–43
- Recovering from zero brightness readout, 3–12
- REF, setting reference mode, 3–44
- Reference, 3–1
 - REF button, 2–4
 - setting mode, 3–44
- Related manuals, xi
- REMOTE
 - connector pin assignments, B–2
 - description, B–1
 - rear panel overview, 2–7
- Remote Commands, C–1
 - AFC, C–51
 - ALLEV?, C–31
 - ARROWhead:FORMat, C–8
 - ARROWhead:LIMIT:NTSC, C–7
 - ARROWhead:LIMIT:PAL, C–7
 - buffering code, C–55
 - CALSignal:ENable, C–53
 - CURsor:CONTROL, C–17
 - CURsor:SElect, C–16
 - DGTL? settings, C–20
 - DGTL:BASE, C–24
 - DGTL:DATA?, C–21
 - DGTL:FREEZE, C–23
 - DGTL:REGion?, C–21
 - DGTL:VDATA?, C–22
 - DGTL:VIDmode, C–23
 - Display positioning commands, C–44
 - DISPlay:FOCUS:, C–30
 - DISPlay:INTENSITY, C–26
 - DISPlay:INTENSITY:READ, C–27, C–28
 - DISPlay:PIXB, C–28
 - DISPlay:PIXC, C–28
 - DISPlay:SCALEillum, C–29
 - DISPlay:SINGLE, C–25
 - DISPlay:TRACEROT, C–29
 - Errors messages, C–31
 - ESR?, C–31
 - EYe:CLOckhpf, C–34
 - EYe:DISPlay, C–33
 - EYe:MODE, C–33
 - FILTer, C–51
 - GAIN:W_V_STATE, C–35
 - GAMut:ALarm:DISPlay, C–9
 - GAMut:ALarm:TRIGger, C–9
 - GAMut:GRATicule, C–8
 - INput:CHANnel, C–39
 - INput:PBPROFFSet, C–39
 - INput:SOUrce, C–38
 - Jitter magnitude query, C–41
 - JITter:HPFILter, C–40
 - JITter:UNITS, C–40
 - LINESelect commands, C–42
 - Marker cursor control, C–17
 - Menu selection commands, C–50
 - NTSC or PAL setting, C–10
 - PORT:ECHO, C–52
 - PREset:NAMES, C–47
 - PREset:REcall, C–46
 - PREset:STORE, C–46
 - REFErence:MODE, C–6
 - ROTEST, C–52
 - Serial number query, C–53
 - SERial:ALarm, C–13
 - SERial:DISPlay, C–12
 - SERial:EAVSAV, C–13
 - SERial:MENU, C–11
 - SERial:MONitor, C–12
 - SLM:CABLE, C–3
 - SLM:LENGTH?, C–5

SLM:LEVEL?, C-5
 SLM:RCVR, C-4
 SLM:SOURCE?, C-4
 SWEEP:MAG, C-49
 SWEEP:TIMING, C-48
 User Interface menu commands, C-14
 Variable GAIN state for Lightning display, C-37
 Variable GAIN state for the WFM and VEC displays, C-36
 Variable GAIN value for the Lightning display, C-37
 Variable GAIN value for WFM and VEC displays, C-36
 VECtor:BARS, C-10
 VECtor:GRAT, C-11
 Voltage and timing cursor positioning, C-18
 Voltage and timing cursor tracking, C-19
 Remote operation, B-1
 Rename, Preset function, 3-43
 Renaming, Preset, 3-43
 Repackaging for Shipment, 1-10
 Replacing
 fuse, D-1
 graticule light bulbs, D-2
 Reset, Serial format checks, 3-46
 Restoring, front panel settings from Preset, 3-43
 RGB, setting Gamut alarm, 3-33
 RGB gamut, Diamond Display, 3-29
 Rise time
 calculating actual, 3-25
 serial channel measurements, 3-24
 RS232
 connector pin assignments, B-1
 rear panel overview, 2-7

S

Safety Certification Compliance, A-10
 Safety Standards, A-10
 Sample, selection using Line Select, 3-39
 SAV Placement, Serial format checks, 3-48
 SAV-EAV, in Configure WFM/VEC menu, 3-9
 Saving, front panel settings as Preset, 3-43
 Screen, filter part number, 1-2
 SER A/B inputs, 2-7
 SER ALARM, configuration menu, 3-11
 SERIAL, 2-4
 Serial A Input, Loop-through input, 2-7
 SERIAL A/SERIAL B, 2-4
 Serial Alarm, configure menu, 3-11
 Serial B input, Loop-through input, 2-7
 Serial channel measurements
 aberrations, 3-23

 amplitude, 3-22
 jitter, 3-26
 rise time, 3-24
 word correlated behavior, 3-27
 Serial format, 3-44
 10/8 Bits, 3-46
 ANC Checksum, 3-49
 ANC Parity, 3-48
 AP CRC ERR SEC, 3-46
 APPROX CABLE LENGTH, 3-49
 Approximate Cable Length for firmware V1.X, 3-47
 Audio, 3-46
 CABLE screen, 3-49
 CABLE TYPE, 3-50
 CABLE TYPE for firmware V1.X, 3-47
 Changed Since Reset, 3-46
 Data Range, 3-48
 DISPLAY, 3-50
 Display, 3-46
 Elapsed Time, 3-46
 F1 AP CRC Value, 3-46
 F2 AP CRC Value, 3-46
 FF CRC ERR SEC, 3-46
 Field Length, 3-48
 525/625 Lines, 3-46
 Format Error, 3-46
 FORMAT screen, 3-48
 Line Length, 3-48
 Other ANC Data, 3-46
 RECEIVER POWER LEVEL, 3-49
 Reset, 3-46
 SAV Placement, 3-48
 Serial Signal Level for firmware V1.X, 3-47
 Signal Present, 3-46
 SOURCE SIGNAL LEVEL, 3-49
 STATUS screen, 3-45
 STATUS screen for firmware V1.X, 3-47
 Stuck Bits, 3-46
 Serial readout screen
 Cable, 3-49
 Format, 3-48
 Status, 3-45
 Status for firmware V1.X, 3-47
 Serial Signal Level, serial format for firmware V1.X, 3-47
 Service manual, 1-3
 Settings, saving as Preset, 3-43
 1700F00 Cabinet, 1-6
 1700F02 Portable cabinet, 1-6
 1700F04 side-by-side rack mount assembly, 1-6
 75 ohm terminator, 1-2
 Shipping instrument, 1-10

S

- Signal
 - receiver power level, 3–49
 - source signal level, 3–49
- Signal Present, Serial format selection, 3–46
- Software Version Number, 3–12
- Specifications, A–1
 - Certifications and Compliances, A–11
 - Electrical Specifications, A–1
 - Environmental Characteristics, A–9
 - Physical Characteristics, A–9
 - Safety Certification Compliance, A–10
 - Safety Standards, A–10
- STANDARD, Format configure menu, 3–11
- Standard (NTSC/PAL), Glossary–3
- Standard accessories, 1–2
- Standby mode, 1–11
- Status, automated serial format, 3–44
- Status Screen, 3–45
- Status Screen for firmware V1.X, 3–47
- Store, Preset function, 3–43
- Stuck Bits, Serial format selection, 3–46
- SWEEP
 - Line/Field, 2–4
 - MAG, 2–4
- Sweep, 3–52
- SYNC, Format configure menu, 3–11
- Sync reference, setting, 3–44

T

- 10 Eye, Eye Pattern trigger mode, 3–21
- 10/8 Bits, Serial format selection, 3–46
- Termination, line discussion, 1–13
- Terminator, 75 ohm part number, 1–2
- Time, readout on Serial format screen, 3–46
- Time per div
 - setting, 3–36
 - setting with Sweep, 3–52
- Timing
 - jitter measurement with Eye Pattern, 3–26
 - measurement with Bowtie, 3–6
- Timing cursors, 3–13
- Trace
 - intensity, 3–12
 - rotation, 3–12
 - selecting number of lines, 3–52
- Trigger
 - modes for Eye Pattern display, 3–20
 - Overlay mode for Eye Pattern, 3–20
- 2T Pulse to Bar, special graticule, 3–36

U

- User Service, D–1
 - cleaning, D–3
 - cleaning the fan filter, D–1
 - replacing graticule light bulbs, D–2
 - replacing the CRT filter, D–3
 - replacing the fuse, D–1
- Using, Menus, 2–5

V

- Variable Gain, 3–28
- Vector Display, 3–53
 - amplitude measurement, 3–54
 - flesh tone indicator, 3–54
 - graticule, 3–54
 - how Pb and Pr create display, 3–53
 - in Functional Check, 1–21
 - Lightning Display, 3–55
 - phase measurement, 3–54
 - timing measurement, 3–55
 - vector timing measurement, 3–55
- Vectorscope, Vector Display, 3–53
- Version, determining software version, 3–12
- Vertical
 - Gain, 3–28
 - gain calibration, 3–7
- Vertical scale, waveform graticule, 3–34
- Video
 - mode in Digital List display, 3–14
 - mode in Digital Waveform display, 3–16
 - viewing with Picture Display, 3–42
- VIDEO IN, 2–4
 - Serial Inputs, 3–58
 - setting mode in Configuration menu, 3–58
- Voltage cursors, 3–13

W

- Waveform
 - Digital Waveform display, 3–16
 - jitter, 3–38
 - Parade Display, 3–41
 - viewing jitter, 3–37
- Waveform Display, 3–58
 - filter selection, 3–27
- Waveform display, using Line Select, 3–58
- Waveform graticule

horizontal scale, 3–36
vertical scale, 3–34
WFM AS, in Configure WFM/VEC menu, 3–9
WFM/VEC, configure menu, 3–9
Word correlated behavior, serial channel measurements,
3–27

Word rate trigger, 3–21

Y

YPbPr Parade, 3–41

